



TRUST THE CONSUMABLES
ENGINEERED
 FOR YOUR INSTRUMENTS

INTERACTIVE PDF

JCANO INGENIERIA DE MÉXICO:

Priv. Brunel Mz. 1 Lt. 5 Cs 4-B Fracc. Quinta Versailles C.P. 55767 Tecámac, Edo. De México

Correo: mcano@jcanoingenieria.com

Página Web: <https://jcanoingenieria.com>

Tel: 55 3996 2586

Facebook: <https://www.facebook.com/JCanoIngenieria>

WhatsApp: 55 7129 9832

2020-2022 Materials Characterization Consumables and Supplies

FT-IR | UV/Vis/NIR | Elemental Analysis | Thermal Analysis | Hyphenated Techniques



Materials Characterization

Today's advanced and increasingly diverse Advanced Materials laboratories are facing new challenges on a daily basis – starting from raw materials right up to the finished product. PerkinElmer's comprehensive portfolio of analytical solutions is designed to give you the higher accuracy, sensitivity, and ease of use your laboratory demands for examining with confidence, the purity, composition, and performance of your compounds. What's more, a range of complementary services is available to keep your laboratory up and running, meeting the stringent requirements of a variety of environments and working practices.

Better insights for better products.

CHOOSE PERKINELMER.

Ordering Information

Place your order online at: www.perkinelmer.com/shop

Online ordering is currently available in Australia, Austria, Belgium, Canada, China, Denmark, Finland, France, Germany, Ireland, Italy, Luxemburg, the Netherlands, Norway, Puerto Rico, Singapore, Spain, Sweden, Switzerland, the United Kingdom and the United States.

Please contact your local PerkinElmer Customer Care Representative.
Or visit www.perkinelmer.com/lasoffices.

Visit us online at www.perkinelmer.com/lasoffices to obtain the correct address for mailing your company Purchase Order.

Return Goods Policy

Before returning any item to PerkinElmer, please obtain a Return Authorization Number from a customer service representative. Call your local PerkinElmer office and please have the following information ready:

- Our Order Number or your Purchase Order Number.
- The PerkinElmer part numbers of the items that you wish to return.
- Reason for return.

Our customer service representative will provide you with a Return Authorization Number and the return address. We cannot accept any returns without a Return Authorization Number. Policy may vary. Please contact your local PerkinElmer representative for details.

Technical Support

For technical assistance, please contact your local PerkinElmer Customer Care Representative. See local office listings.

Check with your local PerkinElmer Customer Care center for current pricing.

PerkinElmer and the PerkinElmer logo are registered trademarks of PerkinElmer, Inc. All other product and company names mentioned herein may be the trademarks or registered trademarks of their respective owners.

PerkinElmer is not responsible for typographical or photographic errors that may appear in this catalog. We reserve the right to make adjustments or corrections due to changing market conditions, product discontinuations, or typographical or photographic errors in advertisements or product descriptions. Terms and conditions and item availability are subject to change without notice.

Terms and Conditions

For details on our terms and conditions, including warranties, please visit: www.perkinelmer.com/terms

Table of Contents

Fourier Transform Infrared Spectroscopy

PerkinElmer offers a wide selection of superior quality FT-IR products designed to work with your PerkinElmer instruments. Our precision designed products deliver the peace of mind that comes from knowing that you'll get the results you need.

Quick Reference Index Page

Attenuated Total Reflectance (ATR) Accessories

PerkinElmer delivers wide variety of top, trough, and flat plates to support their state-of-the-art Universal ATR and Horizontal ATR accessories.



Reflectance Accessories

To support reflectance measurements, PerkinElmer offers a wide variety of sampling accessories and tools, from top-performing fiber probes to basic microsampling tools.



OilExpress Supplies

PerkinElmer supplies all the tools, parts, and consumables required for performing in-service lubricant analysis using the OilExpress 4.



FT-IR Maintenance Kits

Dessicant kits, required for all PerkinElmer's FT-IR spectrometers, keep instrument optical paths moisture-free. This kits come as either rechargeable or disposable kits.



Sampling and Starter Kits

New to FT-IR spectroscopy? Don't worry. PerkinElmer offers sampling, starter, and educational kits designed to familiarize the new user with the tools and best practices of FT-IR analysis.



HUMAN HEALTH

ENVIRONMENTAL HEALTH

OVERCOME YOUR BIGGEST CHALLENGES AND YOUR SMALLEST

© 2015 PerkinElmer, Inc. 400315_02. All trademarks or registered trademarks are the property of PerkinElmer, Inc. and/or its subsidiaries.



IR microscopy where everything's routine – except the results.

Macro or micro, your challenges come in all shapes and sizes. And that's the whole idea behind our Spotlight™ 200i/150i FT-IR microscope systems. They combine high-performance IR microscopy with full-featured FT-IR that's ideal for any size sample, with a routine, stepwise workflow that makes setup, scanning and analysis simple and straightforward. And that workflow is compressed by intelligent automation, including particle finding and laminate detection, aperture optimization, ATR setup, region-of-interest location, and more. The amazing Spotlight 200i/150i systems, the workflow is routine - the results are anything but.



Fourier Transform Infrared Spectroscopy (FT-IR) Instruments



Spectrum 3 Series

Fast-scanning spectrometers that can be configured for near-, mid-, and far-infrared techniques.

The six available configurations are:

Spectrum 3 MIR – The industry standard for mid-infrared spectrometry. Extended MIR/NIR range available.

Spectrum 3 NIR – Offers high-performance NIR testing.

Spectrum 3 Optical – Delivers optical filter measurements.

Spectrum 3 MIR/NIR – Provides both MIR and NIR capabilities.

Spectrum 3 MIR/FIR – Full-featured FT-IR system with advanced far-IR capability.

Spectrum 3 MIR/NIR/FIR – This tri-range configuration performs analysis in all three infrared ranges.

- More optimized sampling choices than other FT-IRs in its class.
- Dynascan™ fixed mirror-pair interferometer doesn't require dynamic alignment mechanisms.
- Electronically-stabilized source hot spot for long-term measurement and alignment stability.

Applications:

- Material contaminant identification.
- Pharmaceutical counterfeit studies and impurity identification.
- Packaging and coating analysis.
- Characterization of synthesized materials, semiconductors, and novel laser and detector devices.



Spectrum Two MIR

Easy to operate, portable design for everyday MIR analyses.

- Low-maintenance, compact and easily transported with optional wireless connectivity and handheld PC control.
- Can be operated by anyone, regardless of experience level.
- Dynascan™ interferometer doesn't require dynamic alignment for error compensation.
- OpticsGuard™ humidity shield protects instrument from environmental effects.
- AVC digital filtering algorithm compensates for CO₂/H₂O absorptions.
- AVI standardization uses gas phase spectra for accurate calibration.
- Optional high-performance Deuterated TriglycineSulfate (DTGS) MIR detector, with a SNR of 14,500:1, is ideal for lowlight, high-throughput applications.

Applications:

- Pharmaceutical research and pharmacopeia compliance.
- Teaching IR methods in academic labs.
- Characterization of fuels, lubricants, and oils.
- Polymer analysis.



Spectrum Two NIR

Portable NIR with the highest sensitivity and reproducibility.

- Available with LiTaO₃ or InGaAs photodiode detectors with an internal filter wheel as standard.
- Can be used in transmission mode and various other sampling modes, including reflectance.
- Can be operated by anyone, regardless of experience level.
- Heatable Transmission Module for edible oil testing applications.
- Highest sensitivity and reproducibility for NIR reflectance sampling.
- Dynascan interferometer that doesn't require dynamic alignment for error compensation.

Applications

- Identification of raw pharmaceutical materials.
- Crystallization behavior and solid fat content of specialty fats.
- Hydroxyl number of polyols in polyurethane manufacturing.
- Determination of the THCA/CDBA potency ration in ground cannabis flower.



Spotlight 150i/200i

Microscopy system with superior signal-to-noise ratio and wide spectral range.

- Automated setup with configurable validation routines.
- Can be operated in transmission, reflectance, and automated micro-TR for maximum sampling flexibility.
- Fully compatible with PerkinElmer Spectrum 3/Frontier, Spectrum Two/65/100/400 FT-IR Systems.
- Requires minimal sample preparation while maintaining spectral integrity.
- Can be upgraded to a Spotlight 400 Imaging System and customized to provide full imaging capabilities.

Applications:

- Analysis of materials including biomaterials and pharmaceuticals.
- Forensic analysis of paint chips, drugs, fibers, and explosives.
- Diagnostic biomedical research and tool development.

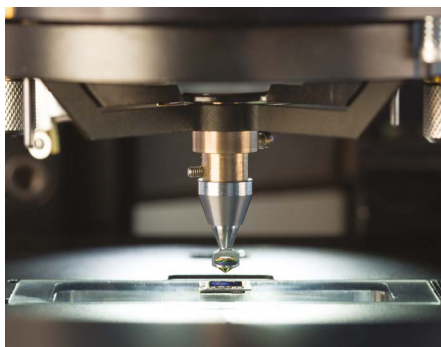

Spotlight 400/400N

Full-featured FT-IR spectrometer and macro-sampling system.

- Optional stage mounted Germanium ATR imaging crystal.
- High quality spectral production and images from sample areas, yielding pixel resolutions of 6.25, 25, or 50 microns.
- Region of Interest (ROI) finding to allow for ease of analysis of multiple particles and layers all at once.
- Unattended operation with automated mathematical data analysis routines.
- Fully compatible with PerkinElmer Spectrum 3/Frontier, Spectrum 65/100/400 FT-IR Systems to give maximum information from samples in the shortest possible time.
- Extended-range IR imaging to below 600 cm^{-1} and dedicated, highest performance NIR imaging.

Applications:

- Accelerate materials product development and improvement.
- Distinguish between genuine and counterfeit pharmaceuticals.
- Efficient biomedical and academic research.
- Examine composition of biomaterials and the biomaterial-host interface.



OilExpress 4

Highly automated, rapid, and reliable oil conditioning monitoring system. Multiple upgrade packages available to meet individual throughput needs.

- Two autosampler options: Mini (192 samples) and XL (384 samples).
- 1 FT-IR (70 samples/hour), 2 FT-IR (110 samples/hour), Dual purpose (IR and dilution capabilities).
- Precision syringe system with vacuum assistance for accurate sample dispensing.
- Disposable sample tips avoid cross-contamination.
- Fluid control sensors detect sample height, system pressure, and waste overflow.
- Shuttle station obtains background reference spectra automatically.
- Dedicated user interface with LIMS import/export.
- Powered by high performance, low maintenance Spectrum Two FT-IR system.
- Modular design that allows you to scale up your sample throughput or separately utilize the oil dilution capabilities.

Applications:

- High-throughput oil and lubricant analysis.
- Oil condition monitoring using industry standard protocols: ASTM® and JOAP.

FT-IR Accessories

Accessories play an important role in FT-IR analysis. Selection of the correct accessory speeds your analyses, increases repeatability of results and minimizes errors. PerkinElmer manufactures a host of high quality, easy-to-use accessories and partners with leading industry providers of branded IR accessories to provide a full range of compatible tools to extend the scope and capabilities of your FT-IR instrument.

From simple transmission spectroscopy techniques to more advanced research analysis, our premium “plug-and-play” accessories, such as UATR and diffuse reflectance, offer ultimate performance with minimum set-up and calibration through their convenient auto-recognition set-up design.

With the widest range of both PerkinElmer designed and manufactured accessories and well-known brands of accessories from our global partners, our selection offers you the best solution for your laboratory's needs.



Infrared Spectroscopy Sampling Techniques

Attenuated Total Reflectance (ATR)

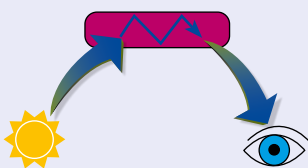

A sampling technique which requires little to no sample preparation. A beam of infrared light passes through the ATR crystal and is reflected off the surface of the sample. The reflection forms an evanescent wave which is collected by a detector.

SAMPLE TYPES:
Solid, Liquid, Powder

APPLICATIONS:
Identification of powders and polymers.
Quantitative measurements for liquids, including aqueous solutions

Diffuse Reflectance

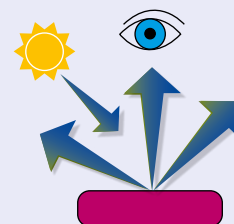

Diffusely scattered light is collected when a beam of light reflects off a rough, matt surface e.g. powder or fiber.

SAMPLE TYPES:
Powders, Fibers, Solids with Rough Surface

APPLICATIONS:
Characterization of minerals and hard plastic materials

Whatever your application or instrument, we have the right sampling accessory for you.

Not every accessory is ideal for every application. That's why we offer a complete line of sampling options for your Spectrum One/100/400/65, Spectrum Two or Spectrum 3/Frontier instruments. With three different levels of sampling accessories to choose from, we'll help you find the solutions that best suit your laboratory needs.



Premium: These top tier accessories offer you the most sampling flexibility. With "plug-and-play" accessory recognition and auto-alignment, you'll be able to quickly and easily analyze a wide range of sample types.



Branded: These mid-level accessories, manufactured by Specac, PIKE and others, have been tested and are approved for use on our PerkinElmer FT-IR systems.



Value: An affordable choice for laboratories that need a simple but effective sampling solution. With manual alignment, these accessories provide you with the performance you need to analyze most samples.

Specular Reflectance

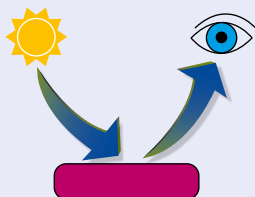

A mirror-like reflection occurs when a beam of light strikes a smooth, shiny surface such that the angle of incidence equals the angle of reflection.

SAMPLE TYPES:
Thin Films on Substrates

APPLICATIONS:
Analysis of coatings on metallic substrates, Langmuir Blodgett films and self-assembled monolayers

Transmission

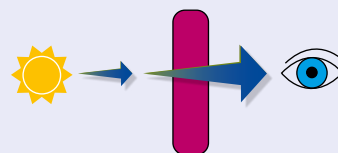

When radiation passes through a body a proportion of the energy is absorbed by the sample and the remainder travels on to the detector.

SAMPLE TYPES:
Solid, Liquid, Gas

APPLICATIONS:
Quantitative determination of fuel properties, e.g. biodiesel, high-resolution gas-phase spectroscopy

Attenuated Total Reflectance (ATR) Accessories

PerkinElmer Universal ATR (UTAR) Accessory



An excellent general accessory for the analysis of solids and liquids. The UATR produces high quality spectra through the use of a pressure arm. The pressure arm force indicator ensures sample-to-sample and operator-to-operator reproducibility. The accessory is recognized when it is placed in the sample compartment, the

optics are automatically optimized and the system is ready to be used without additional alignment.

Description	Spectrum One/100/400/65 Part No.	Spectrum 3/ Frontier Part No.
UATR Diamond/ZnSe ATR (Single Reflection)	L1250050	L1280301
UATR Diamond/KRS-5 ATR (Single Reflection)	L1250053	L1280304
UATR Germanium ATR (Single Reflection)	L1250054	L1280305
UATR Diamond/ZnSe ATR (3 Reflection)	L1250051	L1280302
UATR Diamond/ZnSe ATR (9 Reflection)	L1250052	L1280303
Liquid UATR Diamond/ZnSe (9 Reflection)		L1280069
UATR Pressure Arm O-Ring ID: 3 mm; 1.5 mm CS N70	L9001020	L9001020

PerkinElmer Spectrum Two UATR

Description	Spectrum Two Part No.
UATR Diamond/ZnSe ATR (Single Reflection)	L1600107
Spectrum Two UATR Top Plate Replacement	L1600225
Spectrum Two UATR Adhesive-Free Top Plate for Additional Solvent Resistance	L1600371
Medium Diameter UATR Shoe	L1601742
Large Diameter UATR Shoe	L1601743
UATR Pressure Arm O-Ring	L9004319

PerkinElmer Horizontal ATR (HATR) Accessory

Available in Premium and Value versions this accessory is supplied with a top-plate fitted with a 25-reflection, 45°, 50 mm ZnSe crystal, allowing simple sampling of solids, films and powders.

Description	Spectrum One/100/400/65 Part No.	Spectrum Two Part No.	Spectrum 3/ Frontier Part No.
Premium HATR with ZnSe Flat Top Plate	L1200311		L1280308
Premium HATR with ZnSe Trough Top Plate	L1200312		L1280312
Value HATR with ZnSe Flat Plate		L1600113	L1280321
Value HATR with ZnSe Trough Plate		L1600109	L1280322

ATR Base Plates and Bibs

Base Plates ensure accessories are properly mounted and aligned in the spectrometer's sample compartment. Bibs surround the ATR's top plate to protect the accessory from sample spillage.

Description	Spectrum One/400 Part No.	Spectrum Two Part No.	Spectrum 3/ Part No.
Base Plate	L1250302	L1600217	L1250302
Bibs (Aprons)	L1251816	L1601856	L1251816

ATR Quest™ (Specac)

The Quest ATR Accessory, a single-reflection ATR, specializes in mid- and far-infrared analysis. With innovative optical design and durable monolithic diamond ATR crystal option.



Description	Spectrum 3/ Frontier Part No.
Quest ATR Accessory with Diamond Top Plate	L1272503
Quest ATR Accessory with Diamond (Extended Range) Top Plate	L1272504
Quest ATR Accessory with ZnSe Top Plate	L1272505
Quest ATR Accessory with Ge Top Plate	L1272506
Additional Quest Top-Plates	
Quest ATR Diamond Crystal Top Plate	L1272511
Quest ATR Diamond Extended Range Crystal Top Plate	L1272512
Quest ATR ZnSe Crystal Top Plate	L1272513
Quest ATR Ge Crystal Top Plate	L1272514

Golden Gate™ ATR Accessory (Specac)

A high performance single reflection monolithic diamond ATR product offer, featuring a Type IIIA diamond ATR element metal-bonded into a tungsten carbide mount to provide outstanding durability and exceptional chemical resistance. The robust design allows this ATR accessory to be used to achieve high-quality spectral data in the analysis of a broad range of materials including those that are abrasive, hard, reactive, or corrosive.



Description	Spectrum 3/ Frontier Part No.
Golden Gate Diamond ATR (Single Reflection)	L1272407

Gateway™ HATR Accessory (Specac)

An entry-level multi-reflection (six reflections) horizontal ATR accessory. The rugged design and simple optical layout ensures optimum performance.



Description	Spectrum Two Part No.	Spectrum 3/ Frontier Part No.
Gateway HATR with ZnSe Flat and Trough Top Plates	L1272330	L1272412
Gateway HATR with ZnSe with Electrical Heating to 200°C. Requires Gateway Controller (Territory Dependent)	L1272414	L1272414

25 Reflection ATR Accessory (Specac)

A vertically mounted ATR crystal accessory capable of being operated for a crystal incidence angle of between 30–60°. 25 Reflections are achieved at the 45° angle. The large number of reflections and range of incident angles makes this accessory ideally suited for the enhancement of small bands in weakly absorbing samples.



Description	Spectrum Two Part No.	Spectrum 3/ Frontier Part No.
25 Reflection ATR Accessory with KRS-5 crystal	L1272372	L1272372

ATR Miracle Accessory (PIKE)

Single Reflection HATR accessories specialize in the analysis of highly absorbing solid, semi-liquid, and liquid samples. The sampling plate's small round crystal ensures reliable analysis of small sample volumes.

Description	Spectrum One/100/400/65 Part No.	Spectrum Two Part No.	Spectrum 3/ Frontier Part No.
Miracle Diamond ATR (Single Reflection)	L1272483	L1600114	L1272483
Miracle ZnSe ATR (Single Reflection)	L1272126	L1600115	L1272126
Miracle Ge ATR (Single Reflection)	L1272127	L1600116	L1272127

Multiple (10) Reflection HATR Accessory (PIKE)

Provides high sensitivity for analysis of low concentration components in liquid, solid, and polymer samples. Available with a selection of crystal materials and high temperature configurations.

Description	Spectrum Two Part No.	Spectrum 3/ Frontier Part No.
Multiple (10) Reflection HATR with ZnSe Flat and Trough Plate	L1272337	L1272384

The GladiATR Vision™ (PIKE)

A sampling tool which couples small area infrared analysis with simultaneous viewing. Samples are placed face down and positioned on the diamond crystal while its image is projected in real-time on the LCD screen. Analysis of thick or non-transparent samples is enhanced because viewing is through the diamond crystal. The 110X magnification of the sample image enables the positioning of small samples for optimized analysis.



Description	Spectrum 3/ Frontier Part No.
GladiATR Vision/Video/PC Connection	L1272381
GladiATR Diamond	L1272423

The Variable Angle ATR (VATR) Accessory (PIKE)

This accessory has the ATR crystal mounted vertically and an optical layout is based on an optimized Gilby configuration which allows continuous adjustment of the incident beam angle between 30–60°. Suitable for the analysis of solids, films and coatings. A unique mirror adjustment mechanism which utilizes mirror placement and proportional pivoting allows precise and repeatable alignment.

Description	Spectrum 3/ Frontier Part No.
Classic VATR (25 mm). Choose a 25 mm Crystal	L1272386
Classic VATR (50 mm). Choose a 50 mm Crystal	L1272443

Description	25 mm Crystal Part No.	50 mm Crystal Part No.
KRS-5, 45° Parallelogram	L1272387	L1272388
KRS-5, 60° Parallelogram	L1272389	L1272390
ZnSe, 45° Parallelogram	L1272391	L1272392
ZnSe, 60° Parallelogram	L1272393	L1272394
Ge, 45° Parallelogram	L1272395	L1272396
Ge, 30° Parallelogram	L1272397	L1272398
Ge, 60° Parallelogram	L1272399	L1272400
Si, 45° Parallelogram	L1272401	L1272402

PerkinElmer ATR Top Plates

PerkinElmer ATR Top Plates & Options Compatible with Spectrum One, 100, 400, 65/Spectrum Two/Spectrum 3/Frontier



Description	Part No.	Spectrum 100/400/65	Spectrum 3/ Frontier
UATR Top Plate Diamond/ZnSe (1 Reflection)	L1250240	✓	✓
UATR Top Plate Diamond/ZnSe (3 Reflection)	L1250241	✓	✓
UATR Top Plate Diamond/ZnSe (9 Reflection)	L1250242	✓	✓
UATR Top Plate Diamond/KRS5 (1 Reflection)	L1250046	✓	✓
UATR Top Plate Ge (1 Reflection)	L1250048	✓	✓
UATR 3.0 mm Sample Position Plate (for 1 and 3 Reflection UATR's)	L1202023	✓	✓
UATR 7.0 mm Sample Position Plate (for 1 and 3 Reflection UATR's)	L1202024	✓	✓
UATR Polarization Accessory Diamond/ZnSe (1 Reflection Top-Plate and Pressure Arm)	L1280064		✓
UATR Polarization Accessory Diamond/ZnSe (3 Reflection Top-Plate and Pressure Arm)	L1280065		✓
UATR Polarization Accessory Diamond/ZnSe (9 Reflection Top-Plate and Pressure Arm)	L1280066		✓
UATR Heated Top Plate 60°C (Requires Pike Miracle ATR/10 Reflection HATR USB Temperature Controller)	L1272380		✓
UATR Heated Top Plate 130°C (Requires Pike Miracle ATR/10 Reflection HATR USB Temperature Controller)	L1272433		✓
Universal 0.5 mm ATR Shoe with 1.5 mm Diameter Tip (for 1 and 3 Reflection UATR's)	L1202049	✓	✓
Universal 6.0 mm ATR Shoe with 6.0 mm Flat End (for 1 and 3 Reflection UATR's)	L1202050	✓	✓
UATR Cone Shoe (for 1 and 3 Reflection UATR's)	L1201980	✓	✓
Premium HATR ZnSe 45° Flat Plate	L1200313	✓	✓
Premium HATR ZnSe 45° Trough Plate	L1200314	✓	✓
Premium HATR ZnSe 60° Flat Plate	L1200315	✓	✓
Premium HATR ZnSe 60° Trough Plate	L1200316	✓	✓
Premium HATR (Coated for Extended Lifetime) ZnSe 45° Flat Plate	L1200323	✓	✓

Description	Part No.	Spectrum 100/400/65	Spectrum 3/ Frontier
Premium HATR (Coated for Extended Lifetime) ZnSe 45° Trough Plate	L1200324	✓	✓
Premium HATR (Coated for Extended Lifetime) ZnSe 60° Flat Plate	L1200325	✓	✓
Premium HATR Ge 30° Flat Plate	L1200337	✓	✓
Premium HATR Ge 30° Trough Plate	L1200338	✓	✓
Premium HATR Ge 45° Flat Plate	L1200333	✓	✓
Premium HATR Ge 45° Trough Plate	L1200334	✓	✓
Premium HATR Ge 60° Flat Plate	L1200335	✓	✓
Premium HATR Ge 60° Trough Plate	L1200336	✓	✓
Premium HATR AMTIR 45° Flat Plate	L1200343	✓	✓
Premium HATR AMTIR 45° Trough Plate	L1200344	✓	✓
Premium HATR AMTIR 60° Flat Plate	L1200345	✓	✓
Premium HATR AMTIR 60° Trough Plate	L1200346	✓	✓
Premium ATR Pressure Arm Kit	L1200321		✓
Premium Powder press	L1201944		✓
Premium Volatiles cover	L1205436		✓

Description	Part No.	Spectrum Two	Spectrum 3/ Frontier
Value HATR ZnSe Trough Plate	L1360266	✓	✓
Value HATR ZnSe Flat Plate	L1360267	✓	✓
Value HATR Ge Trough Plate	L1360268	✓	✓
Value HATR Ge Flat Plate	L1360269	✓	✓
Value HATR AMTIR-1 Trough Plate	L1360270	✓	✓
Value HATR AMTIR-1 Flat Plate	L1360271	✓	✓
Value HATR KRS-5 Trough Plate	L1360272	✓	✓
Value HATR KRS-5 Flat Plate	L1360273	✓	✓
Value HATR Clamp Assembly	L1360275	✓	✓

Pike ATR Accessories

Accessories should be matched with corresponding top plate.

Description	Part No.	Spectrum One/100/400/65	Spectrum Two	Spectrum 3/ Frontier
Miracle ZnSe Top Plate	L1272130	✓	✓	✓
Miracle Ge Top Plate	L1272131	✓	✓	✓
Miracle Si Top Plate	L1272133	✓	✓	✓
Miracle Diamond/ZnSe composite Top Plate	L1272313	✓	✓	✓
Miracle Heated 60°C Diamond/ZnSe Crystal Plate*	L1272314		✓	✓
Miracle Heated ZnSe Crystal Plate*	L1272315		✓	✓
Miracle Heated 130°C Ge Crystal Plate*	L1272316		✓	✓
Miracle Volatiles Cover	L1272320	✓	✓	✓
Miracle Liquid Retainer with Volatiles Cover	L1272321	✓	✓	✓
Miracle Flat Tip for High Pressure Clamp	L1272323	✓	✓	✓
Miracle swivel Tip for High Pressure Clamp	L1272324	✓	✓	✓
Miracle Concave Tip for High Pressure Clamp	L1272325	✓	✓	✓
Multiple (10) Reflection HATR ZnSe Trough Plate	L1272338		✓	✓
Multiple (10) Reflection HATR ZnSe Flat Plate	L1272339		✓	✓
Multiple (10) Reflection HATR Ge Trough Plate	L1272340		✓	✓
Multiple (10) Reflection HATR Ge Flat Plate	L1272341		✓	✓
Multiple (10) Reflection HATR Heater with ZnSe Trough plate*	L1272342		✓	✓
GladiATR Heated ATR Diamond up to 210°C	L1272422**			✓
GladiATR Ge Crystal Plate	L1272425			✓
Miracle ATR/10 Reflection HATR USB Temperature Controller (220V, UK)	L1272317		✓	✓
Miracle ATR/10 Reflection HATR USB Temperature Controller (220V, Euro)	L1272318		✓	✓
Miracle ATR/10 Reflection HATR USB Temperature Controller (110V, 60Hz)	L1272319		✓	✓
GladiATR USB Temperature Controller (220V, UK)	L1272426			✓
GladiATR USB Temperature Controller (220V, Euro)	L1272427			✓
GladiATR USB Temperature Controller (110V, 60Hz)	L1272428			✓

* Requires L1272317, L1272318 or L1272319.

** Requires L1272426, L1272427 or L1272428.



Top Plate Accessory Gateway ZnSe 45° Flat Top-Plate L1272332

Specac Gateway Accessory

Specac ATR Top Plates & Options

Description	Part No.	Spectrum One/100/400/65	Spectrum Two	Spectrum 3/ Frontier
Silver Gate™ ZnSe Flat Top Plate (Single Reflection)	L1272274	✓	✓	✓
Silver Gate ZnSe Recessed Top Plate (Single Reflection)	L1272276	✓	✓	✓
Silver Gate Ge Flat Top Plate (Single Reflection)	L1272275	✓	✓	✓
Silver Gate Ge Recessed Top Plate (Single Reflection)	L1272277	✓	✓	✓
Gateway HATR ZnSe Electrically Heated Top Plate to 200°C (220V, UK)	L1272331		✓	
Gateway HATR ZnSe Electrically Heated Top Plate to 200°C (220V, Europe)	L1272373		✓	
Gateway HATR ZnSe Electrically Heated Top Plate to 200°C (110V, 60Hz)	L1272374		✓	
Gateway ZnSe 45° Flat Top-Plate	L1272332		✓	✓
Gateway Ge 45° Flat Top-Plate	L1272333		✓	✓
Gateway ZnSe 550µl Flow Through 45° Top Plate	L1272334		✓	✓
Gateway ZnSe Thermocirculating 550µl Flow Through Top Plate	L1272335		✓	✓
Gateway ZnSe Water Heated/ Cooled 45° Top-plate	L1272336		✓	✓
Gateway™ UK Controller	L1272484			✓
Gateway Euro Controller	L1272485			✓
Gateway USA Controller	L1272486			✓
Gateway China Controller	L1272487			✓

Near Infrared Diffuse Reflectance Accessories

PerkinElmer Near Infrared Diffuse Reflectance

The Near Infrared Reflectance Module provides a convenient and sensitive method for analyzing opaque or highly scattering solid samples such as pharmaceuticals, food products, soap powders, coal, clay, soil, paper, painted surfaces, polymer foam, and catalysts.



L1280313

Description	Spectrum Two Part No.	Spectrum 3/ Frontier Part No.
Spectrum 3/Frontier Near Infrared Reflectance Accessory (NIRAI)		L1280313
Spectrum Two Near Infrared Reflectance Module (NIRM)	L1390205	

Sampling Accessories Recommended Parts

PerkinElmer recommends the below vial holder and sample spinners in addition to the sampling accessories that come standard with NIRAI/NIRM units.



Sample Vial Holder Accessory, L1390225

Description	Part No.
Sample Vial Holder Accessory NIRM	L1390225
NIRAI/NIRM 60 mm Spinner	L1280410
NIRAI/NIRM 100 mm Spinner	L1280417

Consumables



60 mm Soda Glass Petri Dishes L9004574

Description	Part No.
90 mm Plastic Petri Dishes Suitable for NIRAI/NIRM 100 mm Spinner (pkg. 600)	L9004575
55 mm Plastic Petri Dishes Suitable for NIRAI/NIRM 60 mm Spinner (pkg. 1620)	L9004578
60 mm Soda Glass Petri Dishes Suitable for NIRAI/NIRM 60 mm Spinner (pkg. 10)	L9004574
100 mm Soda Glass Petri Dishes Suitable for NIRAI/NIRM 100 mm Spinner (pkg. 10)	L9004573
19 mm Glass Vials, 19 mm x 51 mm (pkg. 144)	L9004892
Vials with Caps 8 mm (pkg. 100)	L1390188
Vials with Caps 12 mm (pkg. 100)	L1390189

Spare Parts



L1185153

Description	Part No.
Transreflectance ICRA Liquids Sampler Kit Includes 5 Petri Dish Liquid Reflectors and Bases, NIRA Liquids Sampling Procedure and User Guide	L1185153
Barcode Reader, Hand-Held	L9004196

Reflectance Standards

PerkinElmer offers a variety of Reflectance Standards to help ensure the system is running optimally.



Calibrated Reflectance Standard

Description	Part No.
99% Reflectance Polymer 60 mm, 8 mm x 58 mm, Uncalibrated	L1281920
99% Reflectance Polymer 100 mm, 8 mm x 98 mm, Uncalibrated	L1281921
99% Reflectance Standard 60 mm, 8 mm x 58 mm, Calibrated	L1281922
99% Reflectance Standard 100 mm, 8 mm x 98 mm, Calibrated	L1281923
50% Reflectance Standard 60 mm, 8 mm x 58 mm, Calibrated	L1281924
50% Reflectance Standard 100 mm, 8 mm x 98 mm, Calibrated	L1281925
Reflectance Standards, 60 mm, 8 mm x 58 mm, Calibrated (pkg. 4)	L1281926
Reflectance Standards, 100 mm, 8 mm x 98 mm, Calibrated (pkg. 4)	L1281927
Reflectance Abscissa Standard 60 mm, 8 mm x 58 mm, Calibrated	L1281928
Reflectance Abscissa Standard 100 mm, 8 mm x 98 mm, Calibrated	L1281929
Reflectance Standard Recalibration Service. It is recommended that reflectance standards are re-calibrated after 12 months	L1281930

Sample Cups

Sample cups for DairyGuard™ system, NIRAI, and NIRM are 50 mm, black, round, metal with quartz glass base. These versatile cups can also be used to analyze dry, ground food or agriculture products. All cups use the same disposable backs for convenience.

Description	Part No.
50 mm with Quartz Base	L1281931
50 mm with Quartz Base, Screw Back	L1281932
50 mm Camlock Cup with Quartz Powder Base	L1281933
50 mm with Disposable Backs	L1281934

Remote Sampling Accessories

PerkinElmer Fiber Optic Interface

The PerkinElmer Fiber Optic interface is a high-performance fiber optic interface that fits into the instrument sampling compartment with a dedicated high performance InGaAs detector.



Spectrum Two N RSM
– Remote Sampling Module
Interface **L1390041**

Description	Spectrum Two Part No.	Spectrum 3/ Frontier Part No.
Frontier/Spectrum 3 Fiber Optic Interface		L1250044
Spectrum Two N Fiber Optic Interface	L1390041	

Fiber Probes

If Fiber Probe interface is ordered, order probe and probe stand below separately.



Description	Part No.
Solids Reflectance Probe Triggered 2m	L1390052
Solids Reflectance Probe Triggered 3m – Long Tip	L1390053
Solids Reflectance Probe Triggered 5m	L1390055
NIR Liquids Immersion Probe 1 mm Pathlength	L1181316
NIR Liquids Immersion Probe 10 mm Pathlength	L1181314
NIR Fiber Probe Basic (Non-Triggered)	L1250071

Fiber Probe Holsters/Stands



Fiber Probe Stand, Short
L1390221

Description	Part No.
Frontier/Spectrum 3 Solids Probe Holster (Compatible with L1390052)	L1390052
Spectrum Two N Solids Fiber Probe Stand (Short) (Compatible with L1390052)	L1390221
Probe Stand for Long Tip Probe (Long) (Compatible with L1390053)	L1390222
Probe Stand for Fiber Probe Basic (Compatible with L1250071)	L1390223
Probe Stand for Liquids Fiber Probe (Compatible with L1181314 and L1181316)	L1390224

Spare Parts

Description	Part No.
Fiber Optic Reference Holder (Spectralon not included)	L1251632
Spectralon Reference Material (Compatible with L1390052)	L1241446
Foam Pad (Compatible with L1390052)	L1251445
Spectralon Reference Material (Compatible with L1390221 , L1390222 , L1390223)	L1390198

Diffuse Reflectance Accessories

PerkinElmer Diffuse Reflectance Accessory

Available in Premium and Value versions this accessory provides a convenient and sensitive method for analyzing opaque or highly scattering solid samples such as pharmaceuticals, food products, soap powders, coal, clay, soil, paper, painted surfaces, polymer foam and catalysts. The accessory allows for macro or micro sampling and only requires insertion into the sample compartment to be ready to use.



Description	Spectrum One/100/400/65 Part No.	Spectrum Two Part No.	Spectrum 3/ Frontier Part No.
Premium Diffuse Reflectance Accessory			L1280306
Value Diffuse Reflectance Accessory	L1200351	L1600111	L1280323

Diffuse Reflectance Recommended Parts

Description	Part No.	Spectrum One/100/400/65	Spectrum Two	Spectrum 3/ Frontier
Diffuse Reflection Macrosample Cup	L1201654	✓	✓	✓
Diffuse Reflection Microsample Cup	L1201655	✓	✓	✓
Diffuse Reflection Multi-Purpose Sample Holder	L1201865	✓	✓	✓
Diffuse Reflection Metal-Coated Silicon Carbide Abrasive Pads (pkg. 100)	L1275106	✓	✓	✓
Diffuse Reflection Non-Coated Silicon Carbide Abrasive Sticks (pkg. 100)	L1271021	✓	✓	✓
Diffuse Reflection Metal-Coated Diamond Abrasive Sticks (pkg. 100)	L1275105	✓	✓	✓
Diffuse Reflection Non-Coated Diamond Abrasive Sticks (pkg. 100)	L1275102	✓	✓	✓

EasyDiff Diffuse Reflectance Accessory (PIKE)

A reflectance accessory with pre-aligned optical components and micrometer controlled sample positioning for reproducible, high quality data analysis of powders, solids, minerals, and inorganic solids.



Description	Spectrum Two Part No.	Spectrum 3/ Frontier Part No.
EasyDiff Diffuse Reflectance Accessory	L1272344	L1272344

DiffusIR™ Diffuse Reflectance Accessory (PIKE)

A research grade diffuse reflectance accessory with a large, efficient optical design accommodating optional environmental chambers for thermodynamic studies.



Description	Spectrum 3/ Frontier Part No.
DiffusIR Diffuse Reflectance Accessory	L1272403

Selector™ Diffuse Reflectance Accessory (Specac)

For analysis of powdered and solid samples. An environmental chamber option allows enhanced vacuum, temperature and pressure studies.

Description	Spectrum 3/ Frontier Part No.
Selector Diffuse Reflectance Accessory	L1272409
Selector Diffuse Reflectance Accessory with Environmental Chamber	L1272410

Mid & NIR Integrating Spheres (PIKE)

Mid-IR and NIR sample compartment spheres for reflectance measurements. Samples are placed directly onto the sample port of the upward-looking sphere or over a thin infrared transmitting window. Measurement of diffuse transmission may also be done by placing the sample at the slide mount beam input port. Kits include base optics, MCT detector (MIR) or InGaAs detector (NIR), and base mount.



Mid-IR Integrating Sphere L1272405

Description	Spectrum 3/ Frontier Part No.
Mid-IR Integrating Sphere with ZnSe Windows	L1272405
NIR Integrating Sphere with Borosilicate Windows	L1272406

EasyDiff Reflectance Options

EasyDiff Sample Cup Holder and Base L1272350



Description	Part No.	Spectrum Two	Spectrum 3/ Frontier
EasyDiff Small Sample Cup (pkg. 2)	L1272345	✓	
EasyDiff Large Sample Cup (pkg. 2)	L1272346	✓	
EasyDiff Sample Slide	L1272347	✓	
EasyDiff Silicon Carbide Abrasive Disks (pkg. 100)	L1272348	✓	
EasyDiff Diamond Abrasive Disks (pkg. 50)	L1272349	✓	
EasyDiff Sample Cup Holder and Base	L1272350	✓	
EasyDiff EasiPrep Sample Preparation Kit	L1272351	✓	
EasyDiff Alignment Mirror	L1272352	✓	
EasyDiff Abrasion Kit	L1272375	✓	

DiffusIR Reflectance Options

DiffusIR Environmental Chamber (1000°C) L1272458



Description	Part No.	Spectrum Two	Spectrum 3/ Frontier
DiffusIR Heating Options Requires DiffusIR Temperature Controller (Territory Dependent)	L1272344		✓
DiffusIR Environmental Chamber (1000°C)	L1272458	✓	✓
DiffusIR Environmental Chamber (500°C)	L1272459		✓
DiffusIR Temperature Controller for Environmental Chambers (220V, UK & Euro; 100V, 60 Hz US)	L1272461		✓

Specular Reflectance Accessories

PerkinElmer Fixed Angle Specular Reflectance Accessory

This accessory allows measurements on samples with glassy coatings and reflective surfaces. The sample is mounted horizontally and can be measured using 2, 5 or 10 mm apertures (included).



Description	Spectrum One/100/400/65 Part No.	Spectrum Two Part No.	Spectrum 3/ Frontier Part No.
Fixed Angle (16°) Specular Reflectance Accessory	01860796	L1600119	01860796

PerkinElmer Variable Angle Specular Reflectance Accessory

Using angles of incidence between 15° and 80°, this accessory provides high-quality measurements of glossy, non-scattering flat surfaces or coatings on highly reflective substrates. At high angles, very thin films or coating may be measured.



Description	Spectrum 3/ Frontier Part No.
Variable Angle Specular Reflectance Accessory	01860954

Specular Reflection Set

The Specular Reflection Set accessory measures the direct specular reflectance of coated glazing products using a 6° angle of incidence. Minimum sample size is 50 x 50 mm.

Description	Spectrum One/100/400 Part No.
Specular Reflection Set	L1250600

80Spec Grazing Angle Specular Reflectance Accessory (PIKE)

For the measurement of relatively thin films and mono-molecular layers. Samples are laid face down and the spectrum of the film is measured. Includes base optics, sample masks, polarizer mounts.



Description	Spectrum One/100/400/65 Part No.	Spectrum Two Part No.	Spectrum 3/ Frontier Part No.
80Spec Grazing Angle Specular Reflectance Accessory	L1272248	L1272248	L1272248

10Spec™ Specular Reflectance Accessory (PIKE)

Recommended to measure the reflectivity of glass per ASTM Standard E1585-93. May also be used to measure near-normal reflectivity of a wide variety of surfaces including military devices, reflecting optics, anti-reflective (AR) coated surfaces, and other reflecting and non-reflecting materials.



Description	Spectrum One/100/400/65 Part No.	Spectrum Two Part No.	Spectrum 3/ Frontier Part No.
10Spec Specular Reflectance Accessory	L1272247	L1272361	L1272247

VeeMAX™ III Variable Angle Accessory (PIKE)

Can be used as a specular reflectance or ATR accessory in both single and multiple reflection mode. The angle may be varied continuously from 30–80° by the rotation of a single control. Has a built-in polarizer mount to permit selection of polarization angle without disturbing purge.



Description	Spectrum Two Part No.	Spectrum 3/ Frontier Part No.
VeeMAX III Variable Angle Specular Reflectance Accessory	L1272240	L1272240
VeeMAX III Variable Angle Specular Reflectance ATR Accessory	L1272353	L1272382
ATRMax II Variable HATR Accessory with 45° Trough Plate		L1272383

Pike Specular Reflectance Options

Description	Part No.	Spectrum One/100/ 400/65	Spectrum Two	Spectrum 3/ Frontier
80Spec/VeeMAX Masks	L1272242	✓	✓	✓
KRS-5 Polarizer	L1272243	✓	✓	✓
80Spec ZnSe Manual Polarizer	L1272376	✓	✓	✓
80Spec/10Spec Gold Reflectance Mirror	L1272377	✓	✓	✓
VeeMax ZnSe 45° Flat Plate	L1272450	✓		✓
VeeMax ZnSe 60° Flat Plate	L1272451	✓		✓
VeeMax Ge 45° Flat Plate	L1272452	✓		✓
VeeMax Ge 60° Flat Plate	L1272453	✓		✓
VeeMax Ge 65° Flat Plate	L1272454	✓		✓
ATRMax II Variable Angle Multiple Reflection ATR, 45° ZnSe Crystal	L1272455	✓		✓
ATRMax Ge 45° Trough Plate	L1272456	✓		✓
ATRMax Ge 45° Flat Plate	L1272457	✓		✓

Transmission Accessories

PerkinElmer offers a versatile product line of liquid sampling cells which utilize a specially designed Universal mount suitable for both FT-IR and dispersive instruments, and a wide variety of high-quality window materials to meet your analytical needs. These windows are polished to precise tolerances of flatness.

The first criteria to consider when selecting a window material is the wavelength range over which the spectrum must be measured.

Other important considerations include solubility, reactivity, and the refractive index of the window material with respect to the sample. Sometimes mechanical and thermal characteristics may also be important.

Selecting Window Materials

The following information may be helpful in selecting window materials:

- **Sodium Chloride (NaCl)** is one of the most versatile window materials available, due to its spectral range and low cost. Samples should not contain water because NaCl is hygroscopic. This will cause the windows to fog and become unusable. Store NaCl cells in a desiccator when not in use. NaCl withstands mechanical stress and can be used up to 400°C
- **Potassium Bromide (KBr)** has a slightly wider spectral range than NaCl but is more hygroscopic. Although able to provide good resistance to mechanical shock, KBr is easily cleaved. KBr can be used up to 300°C
- **Calcium Fluoride (CaF₂)** is extremely hard and stable. CaF₂ is not significantly affected by moisture and does not fog. While resistant to most acids and bases, CaF₂ should not be used with ammonium salts

- **Barium Fluoride (BaF₂)** is a relatively hard material, similar to CaF₂. Though less resistant to water than CaF₂, BaF₂ has a wider spectral range. The useful temperature range extends to 500°C. Also, BaF₂ should not be used with ammonium salts
- **Thallium Bromide-Iodide (KRS-5)** has a broad spectral range and a high refractive index, making it ideal for internal reflectance accessories. KRS-5 is slightly soluble in water and bases but insoluble in acids; KRS-5 is toxic and should not be repolished
- **Silver Bromide (AgBr)** is easily scratched and has a tendency to cold flow at room temperature. Although only minimally degraded by water, AgBr will corrode after prolonged contact with moisture and metals. Avoid exposure to ultraviolet lights, as the crystal has a tendency to darken.
- **Zinc Selenide (Irtran-4™)** is similar to Cleartran except that it is somewhat softer and more easily scratched. Irtran-4 is used in total reflectance accessories because of its high refractive index

Window Material	Transmission Range μm	Transmission Range cm^{-1}	Refractive Index at 1,000 cm^{-1}	Solubility G/100 G H ₂ O at 20°C
Sodium Chloride, NaCl	0.25–16	40,000–625	1.49	36
Potassium Bromide, KBr	0.25–26	40,000–385	1.52	65.2
Potassium Chloride, KCl	0.25–20	40,000–500	1.46	34.7
Cesium Iodide, CsI	0.30–50	33,000–200	1.74	160.0 (at 61°C)
Fused Silica, SiO ₂	0.20–4	50,000–2,500	1.42 (at 3,333 cm^{-1})	Insoluble
Calcium Fluoride, CaF ₂	0.20–9	50,000–1,100	1.39 (at 2,000 cm^{-1})	1.51 x 10 ⁻³
Barium Fluoride, BaF ₂	0.20–13	50,000–770	1.42	0.12 (at 25°C)
Thallium Bromide-Iodide, KRS-5	0.60–40	16,600–250	2.37	< 4.76 x 10 ⁻²
Silver Bromide, AgBr	0.50–35	20,000–285	2	12 x 10 ⁻⁶
Zinc Sulfide, ZnS (Cleartran)	1.0–14	10,000–715	2.2	Insoluble
Zinc Selenide, ZnSe (Irtran-4)	1.0–19.5	10,000–515	2.41	Insoluble
Polyethylene (high-density)	16–333	625–30	1.54 (at 5,000 cm^{-1})	Insoluble

Crystal Polishing Kit

The Infrared Crystal Polishing kit quickly restores fogged windows. The kit contains everything necessary to repolish sodium chloride, potassium bromide, or cesium iodide windows. Also included: a smoothing lap, polishing rouge, a sponge, an optical flat, a Selvyt cloth, and an instruction booklet.

Description	Part No.
Crystal Polishing Kit	51001188

Replacement Parts for the Crystal Polishing Kit

Description	Part No.
Selvyt Cloth (pkg. 5)	51001324
Glass Grinding Lap	51001325
Optical Lap	51001326
Cleaning Sponge (pkg. 2)	51001327
Tin Polishing Rouge	51001328



Demountable Cell

Demountable Cells and Windows for Mulls, Capillary Films, Cast Films, and Very Viscous Liquids

Circular windows are used to construct a demountable cell where the sample is placed on one window and the second window is pressed lightly on top of the first. Spacers of various thicknesses can be used to vary the cell pathlength.

Description	Part No.
Universal Demountable Cell	L1270986
1 Window Aligner	04821132
2 Neoprene™ Gasket	L1270512
3 Circular Window (see below)	
4 Spacer (see below)	
5 PTFE Plugs (pkg. 6)	04821008
6 Quick Release Nut	04821131

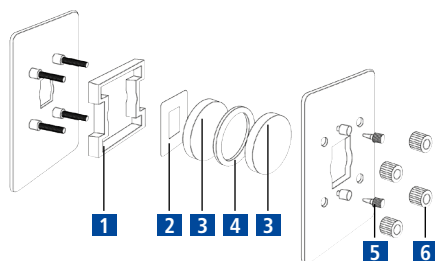

Semi-Demountable Cells and Windows for High-Viscosity Liquids or Mull Samples

By using rectangular windows instead of circular windows, the demountable cell becomes a semi-demountable cell. The semi-demountable cell can be used either as a demountable cell or as a sealed cell for high-viscosity liquids or mull samples. To order a semi-demountable cell, order the Universal Demountable Cell (L1270986) and your choice of semi-demountable windows and spacers.

Description	Part No.
1 Window Aligner	04821132
2 Neoprene™ Gasket	L1270512
3 Undrilled Window (see below)	
4 Spacer (see below)	
5 Drilled Window (see below)	
6 PTFE Plugs (pkg. 6)	04821008
7 Quick Release Nut	04821131

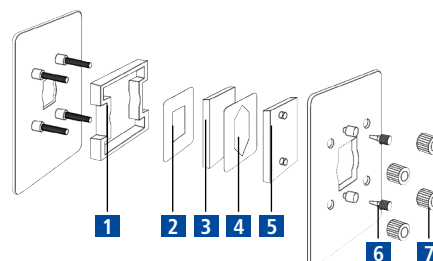

Circular Demountable Cell Windows (Pair)

Window Material	Diameter	Thickness	Part No.
Sodium Chloride	25 mm	4 mm	L1271102
Potassium Bromide	25 mm	4 mm	L1271202
Calcium Fluoride	25 mm	4 mm	L1271602
Barium Fluoride	25 mm	4 mm	L1272002
Thallium Bromide-Iodide	25 mm	4 mm	L1270665
Silver Bromide	25 mm	2 mm	L1272102
Zinc Selenide	25 mm	2 mm	L1270766

Rectangular Semi-demountable Cell Windows (1 drilled; 1 undrilled)

Window Material	Thickness	Part No.
Sodium Chloride	4 mm	L1271191
Potassium Bromide	4 mm	L1271192
Calcium Fluoride	4 mm	L1271193
Barium Fluoride	4 mm	L1271194
Cesium Iodide	4 mm	L1271195
Zinc Selenide	2 mm	L1270765
Silver Bromide	2 mm	L1270666
Thallium Bromide-Iodide	2 mm	L1270664

Circular Spacers

Spacer Material	Thickness	Qty.	Part No.
Lead	0.025 mm	10	L1271250
PTFE	0.05 mm	10	51001135*
PTFE	0.1 mm	6	51001137*
PTFE	0.2 mm	3	51001140*
PTFE	0.5 mm	3	51001141*

* PTFE spacers can be used for the analysis of less viscous samples.

Rectangular Spacers

Spacer Material	Thickness	Qty.	Part No.
Lead	0.025 mm	10	L1270301
PTFE	0.05 mm	6	L1270402
PTFE	0.1 mm	6	L1270404
PTFE	0.2 mm	3	L1270408
PTFE	0.5 mm	3	L1270409
PTFE	1 mm	3	L1270410
Assorted (2 of each)			L1270421



Sealed Liquid Cells for Highly Volatile Samples and Quantitative Analysis

The sealed liquid cells have a corrosion-resistant construction making them ideal for highly volatile samples. The sealed liquid cells are ideal for quantitative analysis where you require an accurate reproducible cell thickness. These cells use a lead spacer which is amalgamated to the window material. The resultant bond forms a good leak-free seal which is effective in preventing evaporation and loss of sample. The sealed liquid cell is an integral unit and cannot be disassembled.

The sample filling orifice is compatible with Luer-Lok™ hypodermic syringes. Two syringes are recommended when cleaning the cell. Never use viscous materials which are difficult to remove from a sealed liquid cell. Instead, use a semi-demountable cell.



Sealed Cell

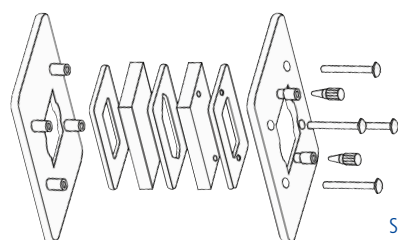

Sealed Cell

Rectangular Sealed Liquid Cells

Window Material	Pathlength	Part No.
Sodium Chloride	0.025 mm	L1270941
	0.05 mm	L1270942
	0.1 mm	L1270944
	0.2 mm	L1270947
	0.5 mm	L1270948
	1 mm	L1270949
Potassium Bromide	0.025 mm	L1270951
	0.05 mm	L1270952
	0.1 mm	L1270954
	0.2 mm	L1270957
	0.5 mm	L1270958
	1 mm	L1270959
Calcium Fluoride	0.025 mm	L1270961
	0.05 mm	L1270962
	0.1 mm	L1270964
	0.2 mm	L1270967
	0.5 mm	L1270968
	0.1 mm	L1270969
Zinc Selenide	0.1 mm	L1270970

Description	Part No.
Luer-Lok Syringe for Sealed Liquid Cells	04967845

Press-N-Lock Demountable Cell

The Press-N-Lock Demountable Cell lets you analyze mulls, smears, viscous films, etc., without the use of nuts, springs, or bolts to keep the cell together. You can use this cell on any PerkinElmer FT-IR spectrometer. The cell consists of a backplate with a Viton™ O-Ring that lets you slip the cover on and off with ease.



Press-N-Lock Demountable Cell

Description	Part No.
Press-N-Lock Demountable Cell	N9302642
O-Rings 25 mm (pkg. 12)	N9302643

Press-N-Lock Demountable Cell Windows (Pair)

Window Material	Diameter	Thickness	Part No.
NaCl	25 mm	4 mm	L1271102
KBr	25 mm	4 mm	L1271202
BaF ₂	25 mm	4 mm	L1272002
ZnSe	25 mm	2 mm	L1270766
CaF ₂	25 mm	4 mm	L1271602

FT-NIR Liquid Cells and Holders

A comprehensive range of FT-NIR cells are available for use with PerkinElmer FT-NIR's and can be found in the cells listing included in the UV section of this catalog.

Window Material	Pathlength	Part No.
Cylindrical Cell Holder	10 mm	L1181303
Cylindrical Cell Holder	50 mm	N9302620
Cylindrical Cell Holder	100 mm	N9302640
Rectangular Cell Holder	50 mm	02200550

Disposable NIR Transmission Cells

The Disposable NIR transmission cells are designed for NIR measurement of aqueous liquids and pastes, in transmission, using a sample pathlength of approximately 0.5 mm. They are made of high density polyethylene (HDPE). Cells are mounted in a 3 x 2 in. backplate which fits into the universal slide mount.



Disposable NIR Transmission Cell (with Holder) L1240056

Description	Part No.
Disposable Cell Holder (pkg. 5)	L1240056
Disposable Cell Holder (pkg. 100)	L1240057

Variable Temperature Cell

Used for the transmission study of solid or liquid samples at temperatures ranging from -190–250°C for solids and -70–250°C for liquids. Holder is supplied with NaCl external windows as standard.



Variable Temperature Cell L1272290

Description	Spectrum One/100/400/65 Part No.	Spectrum Two Part No.	Spectrum 3/ Frontier Part No.
Variable Temperature Cell (220V, UK)	L1272288	L1272356	L1272288
Variable Temperature Cell (220V, Eur)	L1272289	L1272357	L1272289
Variable Temperature Cell (110V, 60Hz)	L1272290	L1272358	L1272290



Solids Sample Holder L1272298

Variable Temperature Cell Options

Description	Part No.	Spectrum One/100/400/65	Spectrum Two	Spectrum 3/ Frontier
Sealed Liquid Cell for Variable Temperature Cell, KBr, 1.00 mm Pathlength	L1272292	✓	✓	✓
Sealed Liquid Cell for Variable Temperature Cell, KBr, 0.50 mm Pathlength	L1272293	✓	✓	✓
Sealed Liquid Cell for Variable Temperature Cell, KBr, 0.10 mm Pathlength	L1272294	✓	✓	✓
Solids Holder for Variable Temperature Cell (Sample size 12–30 mm Diameter and 0.1–0.8 mm Thick)	L1272298	✓	✓	✓
Variable Temperature Cell Holder Jacket KBr windows (Pair)	L1272291	✓	✓	✓
Variable Temperature Cell Holder Flow Fittings Kit	L1272359	✓	✓	✓

Microfocus Beam Condenser

The Microfocus Beam Condenser is a high performance 4x beam condenser. This simple two lens linear optical system ensures easy alignment and high throughput over a wide working wavelength range. Used in conjunction with the DC-2 Diamond Compression Cell, samples are compressed to an ideal thickness for transmission experiments.

Description	Spectrum One/100/400/65 Part No.	Spectrum Two Part No.	Spectrum 3/ Frontier Part No.
Microfocus Beam Condenser with ZnSe Lenses. Requires but does not include DC-2 Diamond Compression Cell	L1272283	L1272354	L1272283
Microfocus Beam Condenser with KRS-5 Lenses. Requires but does not include DC-2 Diamond Compression Cell	L1272284		L1272284
DC-2 Diamond Compression Cell	L1272282	L1272355	L1272355

Beam Condenser

Baseplate mounted for high performance transmission measurements of microsamples and gemstones. Horizontal sample platform for easy sample placement. Compatible with diamond anvil cell accessory. Includes a range of sample apertures 0.5–2.5 mm, and alignment tool.

Description	Part No.
Spectrum Two Beam Condenser	L1600130

The Gasera Photoacoustic PA301 FT-IR accessory

For flexible, rapid analysis of solid, semi-solid, and liquid samples in any form without sample preparation. Specially recommended for black samples, depth profiling, no-sampling preparation, etc. Photoacoustic principle requires low FT-IR/NIR mirror velocity and PA301 is optimized for 2.5 kHz He-Ne laser modulation frequency (or less).



Gasera PA301 Photoacoustic FT-IR Accessory L1272440

Description	Spectrum 3/ Frontier Part No.
Photoacoustic PA301 Accessory	L1272440

Heatable Transmission Module (HTM)

The Heatable Transmission Module (HTM) for the Spectrum Two™ and Spectrum 3 platforms (both FT-IR and FT-NIR) allows for easy elevated temperature measurements on samples in the Mid-IR or Near-IR regions of the spectrum.



Spectrum Two N HTM
– Heatable Transmission Module
L1390029

Description	Part No.
Spectrum Two Heatable Transmission Module	L1390029
Spectrum 3 Heatable Transmission Module	L1370130

Additional HTM Options

Description	Part No.
5 mm Vial Holder Insert	L1390136
8 mm Vial Holder Insert	L1390137
12 mm Vial Holder Insert	L1390138
1 mm Cell Holder Insert	L1390147
5 mm Cell Holder Insert	L1390148
10 mm Cell Holder Insert	L1390149

HTM Demountable Cell Inserts

HTM Demountable Inserts should be ordered with a minimum of one set of windows.

HTM Demountable Cell
Insert with Windows



Description	Part No.
HTM Demountable Cell Insert	L1390046
HTM Demountable Cell Windows – CaF ₂	L1390048
HTM Demountable Cell Windows – KBr	L1390049
HTM Demountable Cell Windows – ZnSe	L1390047

HTM Sample Vials

Description	Part No.
Vials with Caps – 5 mm (100 Vials and 100 Caps)	L1390187
Vials with Caps – 8 mm (100 Vials and 100 Caps)	L1390188
Vials with Caps – 12 mm (100 Vials and 100 Caps)	L1390189

HTM Pre Heat Stations

For maximum HTM throughput we recommend HTM Pre-Heat Stations to bring samples up to measurement temperature.

Description	Part No.
HTM Pre-Heat Station with 8 mm Vial Holder	L1390235
HTM Pre-Heat Station with 5 mm Vial Holder	L1391230
HTM Pre-Heat Station with 12 mm Vial Holder	L1391232
HTM Pre-Heat Station with 1 mm Cell Holder	L1391233
HTM Pre-Heat Station with 5 mm Cell Holder	L1391234
HTM Pre-Heat Station with 10 mm Cell Holder	L1391235

Short Path Demountable Gas Cells

Used to monitor air pollutants, study vapor phase transitions in gas molecules and quantify impurities in gas samples. The Pyrex cells are supplied with a choice of windows.

Note: All require the Universal 10 cm gas cell mount for use.

Description	Spectrum One/100/400/65 Part No.	Spectrum Two Part No.	Spectrum 3/ Frontier Part No.
10 cm Short-Path Demountable Gas Cells with NaCl Windows	51000634	51000634	51000634
10 cm Short-Path Demountable Gas Cells with KBr Windows	51000636	51000636	51000636
10 cm Short-Path Demountable Gas Cells with CaF ₂ Windows	51000638	51000638	51000638
Universal 10 cm Gas Cell Mount	51000817	51000817	51000817

The Storm Short Pathlength (10 cm) Gas Cell (Specac)

Ideal for routine gas and vapor spectroscopic analysis. The cell has a fixed 10 cm pathlength, and is available in Pyrex™ and stainless steel.

Note: The storm Short Pathlength (10 cm) Gas Cell requires the Universal 10 cm Gas Cell mount.



Description	Part No.
Storm Gas Cell (Pyrex) with NaCl Windows	L1272472
Storm Gas Cell (Pyrex) with KBr Windows	L1272473
Storm Gas Cell (Stainless Steel) with NaCl Windows	L1272474
Storm Gas Cell (Stainless Steel) with KBr Windows	L1272475

The Tornado™ Series of Fixed, Long Pathlength Gas Cells (Specac)

Designed for measuring the infrared spectra of gases and vapors at ambient temperatures and pressures. A range of pathlengths is available.

Tornado T10 Gas Cell with Glass Body



Description	Spectrum One/100/400/65 Part No.	Spectrum Two Part No.	Spectrum 3/ Frontier Part No.
Tornado T5 Gas Cell 5 m FPL; Glass Body; KBr Windows	L1272301	L1272370	L1272301
Tornado T10 Gas Cell 10 m FPL; Glass Body; KBr Windows	L1272302		L1272302
Tornado T20 Gas Cell 20 m FPL; Glass Body; KBr Windows	L1272303		L1272303

The Cyclone™ Series of Fixed And Variable Long Pathlength Gas Cells (Specac)

Designed for measuring the infrared spectra of gases and vapors at ambient temperatures and pressures. A range of pathlengths (1–8 m) is available.

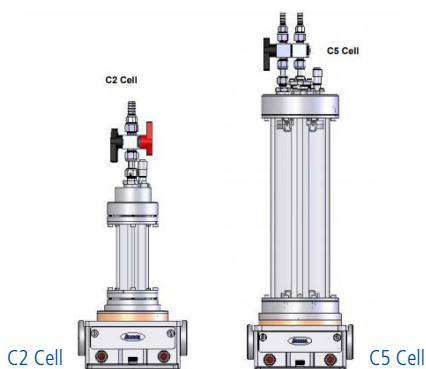

Window Material	Spectrum One/100/400/65 Part No.	Spectrum 3/ Frontier Part No.
Cyclone C2 Gas Cell 0.5–2.5 m; Glass Body; CaF ₂ Windows	L1272470	L1272470
Cyclone C2 Gas Cell 0.5–2.5 m; Metal Body; CaF ₂ Windows	L1272471	L1272471
Cyclone C5 Gas Cell 1-8 m VPL; Glass Body; CaF ₂ Windows	L1272299	L1272299
Cyclone C5 Gas Cell 1-8 m VPL; Metal Body; CaF ₂ Windows	L1272300	L1272300
Cyclone C2 Gas Cell	L1272360	
Cyclone C5 Gas Cell	L1272362	

The Oxford Instrument Optistat DN

A nitrogen reservoir cryostat providing a controlled low temperature exchange gas environment for samples. Designed to operate as an integral part of an optical measurement system.

Description	Spectrum 3/ Frontier Part No.
MIR Optistat DN System (ZnSe Windows)	L1272480
NIR Optistat DN System (Sapphire Windows)	L1272481
FIR Optistat DN System (Polypropylene Windows)	L1272482

Cyclone/Tornado Options

Description	Part No.	Spectrum One/100/400/65	Spectrum Two	Spectrum 3/ Frontier
Cyclone C5 Gas Cell Pressure Gauge	L1272308	✓	✓	✓
Cyclone C2 Gas Cell Heating Jacket and Controller (220V, UK)	L1272364			✓
Cyclone C2 Gas Cell Heating Jacket and Controller (220V, Europe)	L1272365			✓
Cyclone C2 Gas Cell Heating Jacket and Controller (110V, 60Hz)	L1272366			✓
Cyclone C5 Gas Cell Heating Jacket and Controller (220V, UK)	L1272367			✓
Cyclone C5 Gas Cell Heating Jacket and Controller (220V, Europe)	L1272368			✓
Cyclone C5 Gas Cell Heating Jacket and Controller (110V, 60Hz)	L1272369			✓
Tornado/Cyclone Vacuum/ Gas Inlet and Outlet Taps	L1272307			✓

Solid/Liquid/Gas Sampling Starter Packs

Description	Part No.
KBr Disc Starter Pack Includes: Adjustable Adaptor, KBr Die (13 mm) and KBr Pellet Holder	L1272265
KBr Disc Complete Starter Pack Includes: Adjustable Adaptor, KBr Die (13 mm), KBr Pellet Holder, 15 Ton Press and KBr Powder (100 g)	L1272266
Gas Sampling Starter Pack Includes: 10 cm Short-Pathlength Demountable Gas Cell, Spare KBr Windows (47 mm diameter) and Universal Gas Cell Mount	L1272267
Liquid Sampling Starter Pack Includes: Universal Demountable Cell Mount, Circular KBr Windows (pair), Rectangular KBr Windows (pair), 0.1 mm Circular PTFE Spacers (pkg. 6) and Assorted Rectangular Spacers	L1272268

Pearl™ Liquid Analyzer by Specac

The Pearl Liquid Analyzer by Specac greatly reduces the time and difficulty of liquid sample analysis. The Pearl is a high specification liquid transmission accessory designed for laboratory spectroscopic sample analysis in the Near and Mid-Infrared.



The accessory contains Specac's innovative Oyster Cell assembly which holds your sample in a horizontal plane. The design of the Pearl and Oyster Cell allows for fast and easy application of the sample and for cleaning between samples.

For more volatile samples, there is an injection port in the top Oyster so the cell assembly does not have to be fully opened. At all times, the sample can be viewed through the two windows, allowing the user to ensure that no bubbles have been trapped.

The Pearl has been designed to provide a more accurate pathlength than can be achieved when using a traditional liquid transmission accessory, with pathlengths repeatable to significantly less than 1 μm thanks to the innovative Oyster Cell.

Pearl can be fitted with ZnSe or CaF₂ windows, which can be interchanged in seconds. These Oyster Cells are available in six pathlengths: 25 μm, 50 μm, 100 μm, 200 μm, 500 μm and 1000 μm.

The Pearl Oyster cell mechanism is easy to use, making the Pearl Liquid Analyzer suitable for the analysis of highly viscous samples, such as oils and greases.

Pearl Accessories

Description	Part No.
Pearl Accessory for Spectrum 3/Frontier IR	L6310250
Pearl Accessory for Spectrum Two	L6310251



Pearl Oyster Cell Options

Pearl Oyster Cell options consisting of top and bottom windows to make a complete Oyster cell.



Pearl Oyster Cell

Parallel Oyster Cell

Description	Material	Volume	Part No.
Sample Holder Pearl Oyster	CaF ₂	25 μm	L6311024
Sample Holder Pearl Oyster	CaF ₂	50 μm	L6311025
Sample Holder Pearl Oyster	CaF ₂	100 μm	L6311026
Sample Holder Pearl Oyster	CaF ₂	200 μm	L6311027
Sample Holder Pearl Oyster	CaF ₂	500 μm	L6311028
Sample Holder Pearl Oyster	CaF ₂	1000 μm	L6311029
Sample Holder Pearl Oyster	ZnSe	25 μm	L6311036
Sample Holder Pearl Oyster	ZnSe	50 μm	L6311037
Sample Holder Pearl Oyster	ZnSe	100 μm	L6311038
Sample Holder Pearl Oyster	ZnSe	200 μm	L6311039
Sample Holder Pearl Oyster	ZnSe	500 μm	L6311040
Sample Holder Pearl Oyster	ZnSe	1000 μm	L6311041

Wedged Oyster Cell

Description	Material	Volume	Part No.
Wedged Sample Holder Pearl Oyster	CaF ₂	25 μm	L6311030
Wedged Sample Holder Pearl Oyster	CaF ₂	50 μm	L6311031
Wedged Sample Holder Pearl Oyster	CaF ₂	100 μm	L6311032
Wedged Sample Holder Pearl Oyster	CaF ₂	200 μm	L6311033
Wedged Sample Holder Pearl Oyster	CaF ₂	500 μm	L6311034
Wedged Sample Holder Pearl Oyster	CaF ₂	1000 μm	L6311035
Wedged Sample Holder Pearl Oyster	ZnSe	50 μm	L6311042
Wedged Sample Holder Pearl Oyster	ZnSe	100 μm	L6311043
Wedged Sample Holder Pearl Oyster	ZnSe	200 μm	L6311044
Wedged Sample Holder Pearl Oyster	ZnSe	500 μm	L6311045
Wedged Sample Holder Pearl Oyster	ZnSe	1000 μm	L6311046

Oyster Cell Bottom

Description	Material	Volume	Part No.
Parallel Oyster Cell Bottom Assembly	ZnSe	50 μm	L6311052
Parallel Oyster Cell Bottom Assembly	ZnSe	100 μm	L6311053
Wedged Oyster Cell Bottom Assembly	ZnSe	50 μm	L6311054
Wedged Oyster Cell Bottom Assembly	ZnSe	100 μm	L6311055

KBr Presses and Pellets

13 mm Evacuatable Potassium Bromide Die



15 Ton Hydraulic Press

15 Ton Hydraulic KBr Press and Accessories

This bench top easy-to-operate press allows creation of the highest quality KBr pellets. It is used with the Evacuatable KBr die to prepare high quality 13 mm pellets. Requires, but does not include the Evacuatable KBr Die (**51001144**), the KBr Pellet Holder (**04810949**), and the Adjustable Adapter (**L1060351**).

Description	Part No.
15 Ton Hydraulic KBr Press	51004599

15 Ton Hydraulic KBr Press Accessories

Description	Part No.
Evacuatable KBr Die	51001144
Plunger for Evacuatable KBr Die	51001152
Set of Upper and Lower Anvils for Evacuatable KBr Die	04820519
Set of O-Rings for Evacuatable KBr Die	04800514
Perspex Extractor Ring	04977042
KBr Pellet Holder	04810949
Adjustable Adapter to Mount KBr Pellet Holder	L1060351

2 Ton Hydraulic KBr Press and Accessories

This portable KBr press is used to prepare high quality 7 mm KBr pellets. Requires but does not include the 7 mm pellet die and ring holder (**L1272492**) and 7 mm Disc holder with rectangular mount (**L1272493**).



Description	Part No.
2 Ton Hydraulic KBr Press	L1272491

2 Ton Hydraulic KBr Press Accessories

Description	Part No.
7 mm Pellet Die Including Pellet Ring Holder	L1272492
7 mm Spare Pellet Ring Holder (pkg. 2)	L1272494
7 mm Disc Holder with Rectangular Mount	L1272493

Evacuatable KBr Mini-Press

The Mini-press is designed for those situations where you occasionally need to make KBr pellets. This is the simplest solid sample device and is ideal for student use, where very low cost is an important factor. Two highly polished bolts turn against each other in a steel cylinder. The pellet is formed right inside the cylinder which becomes the sample holder. Once formed, the pellet cannot be removed from the cylinder without being destroyed. The Mini-press requires, but does not include, the holder (**51002593**).

Description	Part No.
Evacuatable KBr Mini-Press	51002592
Holder for Evacuatable KBr Mini-Press	51002593

KBr Pellet Quick Press

The Quick Press provides a fast and economical way to prepare good quality KBr pellets. Pellets with diameters of

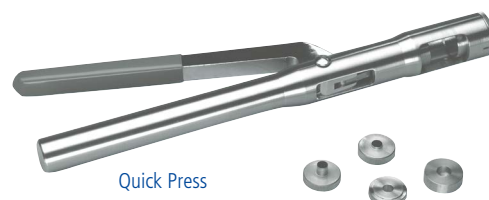

Quick Press

1, 3 or 7 mm can be prepared, depending on the die sets used.

The Quick Press consists of a handpress, a 7 mm die set and a metal collar. Micropellets can be prepared in the Quick Press by purchasing the optional 1 or 3 mm die. The KBr pellet is formed in a metal collar that fits into a Pellet Holder (**51002593**; required, but not included).

Description	Qty.	Part No.
Quick Press with Die	7 mm	01860436
Optional Die	1 mm	01862295
Spare Die	7 mm	01862289
Pellet Holder for Quick Press		51002593

Support Rings for KBr Pellets

Circular paper rings to reinforce your KBr disks. If the amount of sample is limited there are also paper microframes which reduce the size of the pellet to 11 x 2 mm.

Description	Qty.	Part No.
Paper Rings	100	51001148
Microframes	100	51001149

KBr Powder

Description	Part No.
KBr Powder (100 g)	04977043

Spotlight Imaging Accessories

ATR Imaging Upgrade for Spotlight Systems

Recommended option for the Spotlight 400 or 400N which allows convenient imaging of samples up to 10 mm thick. A large precision aligned crystal enables 400 μm areas to be collected to get more information from the sample quickly.

Description	Qty	Part No.
ATR Imaging Upgrade		L1860319
Spare Germanium Crystal	1	L1860317
ATR Imaging Sample Supports	10	L1860318

Large Area ATR Imaging Accessory

Recommended option for the Spotlight 400 which allows convenient imaging of samples up to about 8 mm thick. A large precision aligned crystal enables ca 1100 x 1100 micron areas to be collected to get more information from the sample quickly.

Description	Part No.
Large Area ATR Imaging Accessory	L1860361

Micro ATR Objective Upgrade Kit

This kit upgrades Spotlight 400, Spotlight 200i, Spotlight 100i, and Microscope Systems without ATR Objective with the micro ATR facility. Includes an ATR Objective consisting of a Cassegrain Reflector, mount and Germanium micro ATR crystal with holder. It covers the range 5,500 – 600 cm^{-1} . Includes a spare Germanium crystal and holder.

Description	Part No.
Micro ATR Objective Upgrade for Spotlight 400 Systems	L1860334
Micro ATR Objective for AutoIMAGE Systems	L1860275
Micro ATR Objective for Multiscope Systems	L1860298
Optional/Spare Silicone Crystal with Holder	L1860269
Spare Germanium Crystal with Holder	L1860268

Hot Stage Accessory

Consists of a heating block, which accepts FT-IR windows and a temperature controller. The Hot Stage can heat samples up to 230°C in 1° increments. The Hot Stage is held in the slide clip on the sample stage of a PerkinElmer FT-IR Microscope.

Power Requirement	Part No.
Hot Stage 100/120 V, 60 Hz	N1870184
Hot Stage 220/240 V, 50 Hz	N1870188

Microsampling Tools

PerkinElmer offers a range of tools which allow you to prepare and manipulate samples for infrared microspectroscopy.



Microsampling Tool Kit
N1870151

Description	Part No.
Microsampling Tool Kit Kit Includes:	N1870151
Dissecting Forceps	N9302610
Roller Knife	N9302619
Micro Specimen Tweezers	N9302609
Straight Micro Probe	N9302605
Aluminum Probe Handle	N9302622
Pin Vice	N9302603
ST Microvice for Spotlight	L1860670

Microscope Supplies

Description	Part No.
Holder for 13 mm Sampling Disks	L1861634
Holder for 13 mm Sampling Disks – Includes Gold Mirror	L1860409
Base Microscope Slides – Optical Quality Glass, 1 x 3 in., 1 mm thick for visible observations (pkg. 72)	N9302600
Low-e Microscope Slides – Optical Quality with Infrared Reflective Coating, 1 x 3 in., 1 mm thick for visible observations and infrared reflectance measurements (pkg. 25)	L1272249

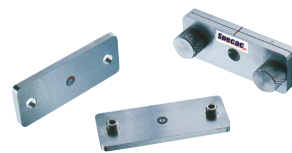

DC-2 Diamond Compression Cell **L1272282**

Compression Cells

Description	Part No.
Diamond Compression Cell This cell consists of two Hastelloy plates containing a pair of diamond windows that enable samples to be compressed to an ideal thickness for transmission measurements	L1272282
Crystal Compression Cell This cell flattens and holds soft samples in optical contact with salt windows. Windows with a 1 and 2 mm thickness and a 13 mm OD can be used with this cell. Two KBr windows (2 mm thickness) are included	N1870185

Infrared Windows

Window Material	Dimensions	Part No.
Barium Fluoride	13 x 1 mm	N9302611
Barium Fluoride	13 x 2 mm	N9302612
Sodium Chloride	13 x 2 mm	N9302614
Potassium Bromide	13 x 2 mm	N9302615

Spectrum 3 Accessories

External GPOB Options

Description	Part No.
General Purpose Optical Bench MCT – Requires External Beam Pack	L1250425*
General Purpose Optical Bench LiTaO3 – Requires External Beam Pack	L1250463*
General Purpose Optical Bench Additional Optics for External Detectors – Requires either L1250425 or L1250463	L1280303*
General Purpose Optical Bench Additional Optics to reproduce sample compartment beam for 3rd party accessories with detectors – Requires either L1250425 or L1250463	L1272501*
General Purpose Optical Bench Additional Optics to reproduce sample compartment beam for 3rd party accessories without detectors – Requires either L1250425 or L1250463	L1272502*

* GPOB fits on the right hand side of the instrument and cannot be co-installed with the second detector MCT if installed in instrument. Choose either GBPB or MCT (or none).

Detector Options for Single Range MIR Instruments

Description	Part No.
NB 1 mm MCT Mid-IR Second Detector for Spectrum 3/Frontier Single Range (factory fit)	L1280249
MB 1 mm MCT Mid-IR Second Detector for Spectrum 3/Frontier Single Range (factory fit)	L1280250
WB 1 mm MCT Mid-IR Second Detector for Spectrum 3/Frontier Single Range (factory fit)	L1280251

Instrument Performance Validation (IPV) Kits

All kits include polystyrene Traceable Reference Material (TRM) for abscissa calibration. The Mid-IR IPV kits include NG11 Schott Glass Reference Material for checking ordinate measurement repeatability.

Description	Part No.
Mid Infrared IPV Kit for Spectrum Software V.6 or Lower	L1250404
Mid Infrared IPV Upgrade Kit for Spectrum Software V.6 or Lower	L1365334
Near Infrared IPV Kit for Spectrum Software V.6 or Lower	L1180479
Near Infrared IPV Upgrade Kit for Spectrum Software V.6 or Lower	L1180490
Mid Infrared IPV Kit for Spectrum 10 Software	L1250404
Mid Infrared IPV Upgrade Kit for Spectrum 10 Software	L1365334
Near Infrared IPV Kit for Spectrum 10 Software	L1250405
Near Infrared IPV Upgrade Kit for Spectrum 10 Software	L1250475
Spectrum 10 and Spectrum ES Data Manipulation Validation and Suitability CD	L1050071

Reference Standards

Description	Part No.
TRM ATR Validation Kit For use with Single Reflection UATR Accessories	L1600133
Methane Test Sample For Manual AVI	L1250462
Spectralon Reference Material For use with Remote Solid Sampling Systems	L1241446
Polystyrene Test Film – 0.038 mm thickness (Not traceable)	L1202057

EGA 4000 Evolved Gas Analyzer

The EGA 4000, a Spectrum 3 accessory, is the world's first in-compartment TGA and Gas cell. Working with the Chiller (N5300002), a compact water circulator, this accessory provides streamlined, cost-effective TG-IR analysis without the need of transfer lines and TGA units.



Description	Part No.
EGA 4000 Evolved Gas Analyzer	N5300001

Spectrum Two Supplies

Spare Parts

Description	Part No.
Spectrum Two Source Replacement Kit	L1600243
Spectrum Two N Source Replacement Kit	L1390110
Spectrum Two ZnSe Window Replacement Kit	L1600242
Spectrum Two KBr Window Replacement Kit	L1600241
Spectrum Two N CaF ₂ Window Replacement Kit	L1390190
Spectrum Two Disposable Desiccant Replacement Kit	L1600244
Spectrum Two Main Board Air Filter	L1061717
Spectrum Two J-Stop Cards	L1600232
Spectrum Two N J-Stop Cards	L1390271
Spectrum Two N InGaAs Attenuator Standards	L1390159
Spectrum Two Power Supply	L9002298

Spectrum Two Portability Options

To allow for full portability the Spectrum Two portability pack (contains battery pack, car adaptor, Spectrum Two carry case and wireless router kit) should be ordered. Portability options may also be ordered individually. Compatible with Spectrum Two and Spectrum Two N.



Description	Part No.
Spectrum Two Portability Pack Includes UPS Battery Pack, Wireless Router and Spectrum Two Carry Case	L1600238
Battery Pack Portable/UPS (Req. Country Power Cord and Incl. 12 V Car Adaptor)	L1600233
Spectrum Two Carry Case	L9004199
Spectrum Two UATR Carry Case	L9004200
Spectrum Two Wireless Router Kit	L1600246
12 V Car Adaptor	L9004128
Wireless USB Key	L9004198

FT-IR Maintenance Kits



Disposable Desiccant Kit

Desiccant Kits

These kits are required for all the PerkinElmer FT-IR Spectrometers to keep the optical path free from moisture. It is recommended that the desiccant is replaced every six months. Follow the instructions in the appropriate instrument manual to install the desiccant.

Disposable Desiccant Kit

User installable desiccant includes two desiccant packs. For each desiccant change, two kits (or four packs) are required. Three kits (or six packs) are required for use with Spectrum 65, 100, 100N and 400.



Description	Part No.
For use with Model 1600, Paragon 500/1000, System 2000, Spectrum One/One NTS/400/1000/2000/BX/GX/RX/65/Spectrum 3/ Frontier	N0171159
Spectrum 2 Dessicant Replacement Kit	L1600244

Recharging Desiccant Kits

The standard kit contains two pairs of rechargeable desiccant packs. This is so you can immediately replace the desiccant in the instrument with re-activated packs. The desiccant packs can be re-activated by baking them in an oven at 250°C for approximately 8 hours. They should be cooled in a dry atmosphere. For optimum results, re-activate the packs immediately before re-use.

Rechargeable Desiccant Kits

The desiccant is contained in rigid metal cages which are user-installable. Depending on the instrument either one or two cages are required.

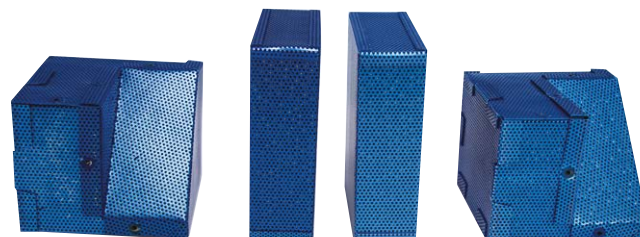

Rechargeable Desiccant Kit for Spectrum One/One NTS

Description	Part No.
For Spectrum Spectrum 65/100/100N/400/Spectrum 3/ Frontier Includes: 4 x Desiccant Packs – two to be used in the instrument and two spares for recharging	L1250311
For Spectrum One/One NTS Includes: 4 x Desiccant Packs – two to be used in the instrument and two spares for recharging	L1200219
For Spectrum 1000/BX/RX, Model 1600, Paragon 500/1000 Includes: One (pkg. 1) Desiccant Pack – one pack required for each desiccant change	L1180480
For Spectrum 400 Second Desiccant area Includes: One (pkg. 1) Desiccant Pack – one required for each desiccant change	L1251840

Replacement Laser Head Kit and Sources

PerkinElmer offers replacement parts, such as laser heads and source lamps, for their FT-IR spectrometers. These items are readily available and most do not require installation by a PerkinElmer Service Engineer.

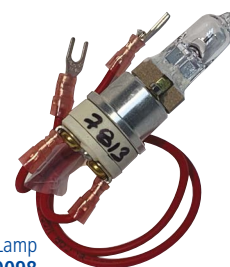

NIR Source Lamp
L1240098

Description	Part No.
Laser Head (HeNe) and Laser Power Supply User-Installable Spare for Spectrum One/65/100/400/ Spectrum 3/Frontier and Spectrum One/NTS/100N Systems	L1200253
NIR Source Lamp for Spectrum One/65/100/400/Spectrum 3/Frontier	L1240098
Mid-IR Source Assembly for Spectrum One/100/400/ Spectrum 3/Frontier	L1200406
Mid-IR Source Element for Spectrum One/65/100/400/ Spectrum 3/Frontier	L1200443
Spectrum Two Source Replacement Kit	L1600243

Sampling and Starter Kits

FT-IR Sampling Kits

Two FT-IR Sampling Kits are available to help the newcomer to FT-IR spectroscopy choose the more frequently required items, and to simplify ordering and storage. KBr has been chosen for the transmitting material. The two kits are packaged in attractive storage and carrying cases. The Liquid and Mull FT-IR Sampling Kit satisfies the needs of most new users of FT-IR spectroscopy. It is designed to provide all the necessary equipment for handling liquids and mulls. The General Purpose FT-IR Sampling Kit includes all of the necessary equipment for handling liquids, mulls, and KBr pellets.



Sampling Kits

Description	Part No.
General Purpose FT-IR Sampling Kit	L1365312*
Liquid and Mull FT-IR Sampling Kit	L1365311

* Not included, a laboratory press for making KBr pellets.

Sampling Kits Contents

Description	Part No.	General Purpose	Liquid/Mulls
Universal KBr Disc Holder	04810949	x	
Nujol DD 057 (100 mL)	04960691	x	x
10 cm Micro Spatula	04967843	x	x
2 mL Luer Syringe	04967845	x	x
Agate Pestle & Mortar	04967854	x	x
Magnetic Film Holder-Circular	04974438	x	x
KBr Power 100 g	04977043	x	
13 mm KBr die	51001144	x	
Micro-Disc Holder Accessory	L1060351	x	
Beam Condenser Accessory	L1160550	x	
100 µm Dia. Sample Holder Accessory	L1160569	x	
500 µm Dia. Sample Holder Accessory	L1160579	x	
MIR Polystyrene Reference Card	L1202057	x	x
Assorted Teflon Spacers	L1270421	x	x
Universal Cell Mount	L1270986	x	x
KBr Rectangular Window (Pair)	L1271192	x	x
KBr Circular Window (Pair)	L1271202	x	x
General Purpose Accessory Kit Box	L1362336	x	
General Purpose Accessory Kit Nameplate	L1362460	x	
Liquid/Mulls Sampling Kit Box	L1362335		x
Liquid & Mull Nameplate	L1362458		x

FT-IR Sampling Kit Supplies

Description	Size.	Part No.
Nujol	100 mL	04960691
Fluorolube	1 oz bottle	01862301
KBr Powder	100 g	04977043
KBr Random Cuttings	100 g	N9300086
Micro Spatula	10 cm	04967843
Luer Syringe	2 mL	04967845
Agate Pestle and Mortar		04967854

Spectrum Two Educational Starter Pack

A convenient kit which will teach you how to make solid and gas transmission measurements. Includes a simple KBr pellet press and pellet holder as well as a 10 cm gas cell and holder. Potassium Bromide not included.

Description	Part No.
Spectrum Two Educational Starter Kit	L1608022

FT-IR Introductory Kit

This kit rapidly familiarizes you with good sampling techniques, proper sampling accessory selection, how to manage atmospheric interferences, signal-to-noise ratio, resolution selection and much more.

Description	Part No.
FT-IR Introductory Kit (1 User)	L1608001
FT-IR Introductory Kit (5 Users)	L1608002

FT-IR Reference Standards

Solid/Liquid/Gas Sampling Starter Packs

Description	Part No.
KBr Disc Starter Pack Includes: Adjustable Adaptor, KBr Die (13 mm) and KBr Pellet Holder	L1272265
KBr Disc Complete Starter Pack Includes: Adjustable Adaptor, KBr Die (13 mm), KBr Pellet Holder, 15 Ton Press and KBr Powder (100 g)	L1272266
Gas Sampling Starter Pack Includes: 10 cm Short-Pathlength Demountable Gas Cell, Spare KBr Windows (47 mm diameter) and Universal Gas Cell Mount	L1272267
Liquid Sampling Starter Pack Includes: Universal Demountable Cell Mount, Circular KBr Windows (pair), Rectangular KBr Windows (pair), 0.1 mm Circular PTFE Spacers (pkg. 6) and Assorted Rectangular Spacers	L1272268

OilExpress 4 Supplies



OilExpress 4 XL DUO

Autosampler

Description	Part No.
Injection Station Tubing Kit	L1600350
Injection Station	L1610021
Hanging Tip Rack	7607537
VersaTip PLUS Tip	5079076
96-Position (8 x 12) 17 x 100 mm Tube Rack	L1610015
32-Position (8 x 4) 4 oz Bottle Rack	L1610016
VersaTip PLUS RoboRack Kit Kit includes: 4 x VersaTip PLUS Adapters, 4 x Tip Stripper Collars, Hanging Tip Rack Holder for 1000 µL Disposable Tips, Disposable Tip Starter Package, 5 Biohazard Bags	7002356
System Liquid Filter Adapter Kit Kit Includes: 4 x 40 Micron Filters (7005398), all necessary fittings and instructions to allow filters to be added to system liquid tubing	7005397
System Liquid Replacement Filter Kit Kit Includes: 4 x 40 Micron Filters for System Liquid Filters. Filters Only. Assumes system liquid tubing has already been adapted using System Liquid Filter Adapter Kit (7005397)	7005398
5.0 mL 4-tip Maintenance Kit Kit Includes: 4 x Syringes, 4 x Valves, 1 x Tubing Replacement Kit, and 1 x Tube of Syringe Pump Lubrication Fluid	7005386
80" x 30" Table, fixed height for OilExpress 4 and OilPrep 4 Table Accommodates Autosampler, FT-IR Computer, Monitor and Keyboard	5085685
System Liquid Detergent Additive, 100 mL	N9308354
System Liquid Detergent Additive, 500 mL	N9308376
System Liquid Detergent Additive, 1 Gallon	N9308380

OilExpress 4 Upgrade Kits

These upgrade kits upgrade OilExpress 4 Single Configuration to the OilExpress 4 DUO configuration. To upgrade from an OilPrep 4 to an OilExpress 4 DUO, order both the Single Upgrade and the Single to DUO Upgrade kits.

Description	Part No.
OilExpress 4 Single FT-IR to OilExpress DUO KBr FT-IR	L160001E
OilExpress 4 Single FT-IR to OilExpress DUO ZnSe FT-IR	L160001F
OilPrep 4 to OilExpress Single KBr FT-IR	L160001G
OilPrep 4 to OilExpress Single ZnSe FT-IR	L160001H

Flow Cell

Description	Part No.
ZnSe Flow Cell	L1272490
ZnSe Cell Windows Kit Kit Includes: Pair of ZnSe Windows (Front and back)	L1272496
Flow Cell Gasket Set	L1272498
Flow Cell Maintenance Kit Kit Includes: Replacement ZnSe Windows (L1272496) and Cell Gasket Kit (L1272498)	L1272495
Citrajel Liquid Acid Cleaner	1 Gal. N0777063
Citrajel Liquid Acid Cleaner	5 Gal. N0777064



Wide Bore Oil Disposable Tips
L1610022

Tubes and Bottles

Description	Part No.
Wide Bore Oil Disposable Tips – Pre-Loaded 1000 µL (pkg. 960)	L1610022
Wide Bore Oil Disposable Tips – Pre-Loaded 1000 µL (pkg. 4800)	L1610023
17 mm OD x 100 mm Tall Tubes (pkg. 1200)	N0777167
Plug/Cap for 17 mm OD Tubes (pkg. 1200) for N0777167 only	N0777599
17 mm Sampling Convenience (pkg. 4800)	N9308904
17 mm OD x 100 mm Tall Graduated Tubes (pkg. 2000)	N0777099
13 x 100 mm Polypropylene Tubes (pkg. 1000)	B0508901
16 mm OD x 67 mm Tall Tubes (pkg. 100)	L1191079
4 oz. Sample Bottle (pkg. 600)	N9308900
2 oz. Sample Bottle (pkg. 600)	N9308901
Used Tip Disposable Drip Tray for OilExpress 4 and OilExpress 4 XL	L1610028
60 mL Trough (pkg. 25)	6008103
60 mL Trough (pkg. 50)	6008104

OilExpress Standards

Description	Matrix	Size	Part No.
In-Service Lubricants FT-IR Control Standard	15W40 Diesel Oil	100 mL	N9308350
In-Service Lubricants FT-IR Control Standard	15W40 Diesel Oil	500 mL	N9308375
OilExpress 4 Test Oil 120 cSt	PAO Oils	500 mL	N9308351
OilExpress 4 Test Oil 360 cSt	PAO Oils	100 mL	N9308352
OilExpress 4 System Liquid Detergent Additive		100 mL	N9308354
OilExpress 4 System Liquid Detergent Additive		500 mL	N9308376
OilExpress 4 System Liquid Detergent Additive		1 Gal.	N9308380
Pathlength Calibration Fluid (Squalane)		50 mL	N9308377
OilExpress 4 Installation Kit (includes N9308350, N9308351, N9308352, N9308354, and N9308377)			N9300850

Spectrum OilExpress Supplies



AutoSampler Spare Parts

Description	Part No.
Insulation Block for Spectrum OilExpress	L1200558
Sample Probe for Spectrum OilExpress	L1200555
OilExpress Flowcell 0.1 mm Pathlength, Wedged Spacer, ZnSe Windows (One Grooved), and Two Ports	L1250220
ZnSe Windows for Spectrum OilExpress Flowcell	L1191081
Gaskets and Spacers for Spectrum OilExpress Flowcell	L1191082
Autosampler Oil Bottle Rack, 30-Position, 4 oz Bottle	L1200551
Autosampler Test Tube Rack, 16 x 6 for 17 x 100 mm Tubes	L1200589
10 mL Syringe with Plunger for Spectrum OilExpress	L1200552
Seal Kit for Spectrum OilExpress (4 Piston Noses)	L1200553
Lubrication Kit for Syringe Pump Screw Drive for Spectrum OilExpress	L1200559
Clamps to Prevent Syringe Barrel from Moving	L1200574

AutoSampler Replacement Tubing

Description	Part No.
Spectrum OilExpress Waste Tubing	L1200560
Sample Needle Tubing for Spectrum OilExpress	L1200587
Flowcell to Syringe Tubing for Spectrum OilExpress	L1200588
Solvent to Syringe Tubing for Spectrum OilExpress (pkg. 2)	L1200556
Injection/Transfer Port to Flowcell Tubing for Spectrum OilExpress	L1200557

Soot Content Standards

Nominal Soot Content Range (%)	Matrix	Size	Part No.
Nominal Soot Content Range: Blank	15W40 Diesel Oil	50 mL	N9308282
Nominal Soot Content Range: 0.5–2%	15W40 Diesel Oil	50 mL	N9308283
Nominal Soot Content Range: 2–4%	15W40 Diesel Oil	50 mL	N9308284
Nominal Soot Content Range: 4–6%	15W40 Diesel Oil	50 mL	N9308285

Soot Content Standard Set

Nominal Soot Content Range (%)	Matrix	Size	Part No.
Nominal Soot Content Range: 0.0, 0.5–2, 2–4, 4–6, 6–9, 9–12wt%	15W40 Diesel Oil	6 x 50 mL	N9308730

Ethylene Glycol Standards

Description	Matrix	Size	Part No.
100 µg/g Ethylene Glycol Standard	Multi-Grade Diesel Engine Oil	80 mL	N9308388
500 µg/g Ethylene Glycol Standard	Multi-Grade Diesel Engine Oil	80 mL	N9308389
600 µg/g Ethylene Glycol QC Standard	Multi-Grade Diesel Engine Oil	80 mL	N9308398
1000 µg/g Ethylene Glycol Standard	Multi-Grade Diesel Engine Oil	80 mL	N9308396
2000 µg/g Ethylene Glycol Standard	Multi-Grade Diesel Engine Oil	80 mL	N9308397
Ethylene Glycol Standards Set	Multi-Grade Diesel Engine Oil	6 x 80 mL	N9308399
Ethylene Glycol Standards Set	Multi-Grade Diesel Engine Oil	80 mL	N9308379

Biodiesel Blends

Description	Matrix	Size	Part No.
100% High Cetane Diesel		20 mL	N9308290
2% (v/v) Biodiesel		20 mL	N9308291
5% (v/v) Biodiesel		20 mL	N9308292
10% (v/v) Biodiesel		20 mL	N9308293
15% (v/v) Biodiesel		20 mL	N9308294
20% (v/v) Biodiesel		20 mL	N9308295
100% (v/v) Biodiesel		20 mL	N9308296

Karl Fischer Standards



Nominal Water Concentration (%)	Matrix	Size	Part No.
Karl Fischer Water in Oil, 0.05%	10W30 Motor Oil	100 mL	N9308298
Karl Fischer Water in Oil, 0.1%	10W30 Motor Oil	100 mL	N9308279
Karl Fischer Water in Oil, 0.5%	10W30 Motor Oil	100 mL	N9308280
Karl Fischer Water in Oil, 1.0%	10W30 Motor Oil	100 mL	N9308281

FT-IR Application Packs

Application packs, described as resource packs or analysis packs depending on whether specific software/calibrations are included, help speed up application development and make your lab more efficient.

FT-IR Introductory Kit

This kit contains samples to rapidly familiarize you with sampling techniques such as Transmission, ATR and Diffuse Reflectance, and preparing a cast thin film. The kit also provides familiarization with IR software including Basic Operation, Quality Checks and Spectral Processing (Search and Compare). The samples included and experiments rapidly demonstrate good sampling technique, sampling accessory selection, managing atmospheric interferences, signal-to-noise ratio, resolution selection and more.

Description	Part No.
FT-IR Introductory Kit (1 User)	L1608001
FT-IR Introductory Kit (5 Users)	L1608002

FT-IR Pharmacopeia Compliance Resource Pack

Designed to assist the user in understanding and achieving compliance to pharmacopeia regulatory requirements in FT-IR analysis, using PerkinElmer Spectrum 10 software and PerkinElmer FT-IR instruments. The pack covers the requirements of seven key Pharmacopoeias (USP, BP, EP, IP, JP, CP and IntPhr).

Description	Part No.
FT-IR Pharmacopeia Compliance Resource Pack Pack includes: FT-IR Pharmacopeia Compliance Resource CD L1050247 FT-IR Pharmacopeia Resource Site License L1101011	L1608004

FT-IR Nutraceutical Compliance Resource Pack

This pack facilitates IR spectroscopy analysis for Nutraceutical and Traditional Medicine professionals. The pack covers the requirements of seven key Pharmacopoeias (USP, BP, EP, IP, JP, CP and IntPhr). The quality assessment of most of natural products is supported by an included nutraceutical starter set of spectra.

Description	Part No.
FT-IR Nutraceutical Compliance Resource Pack Pack includes: Nutraceuticals FT-IR Resource CD L1050260 IR Nutraceutical & TCM Resource License L1101017	L1608005

FT-IR Polymer Resource Pack

Designed for use in the rapid screening and identification of polymer materials using FT-IR Spectroscopy. The pack is designed to help in the measurement of good quality spectra of polymers, identification of polymers, and interpretation of polymer spectra. Utilization of library spectra is illustrated for effective results.

Description	Part No.
FT-IR Polymer Resource Pack Pack includes: Polymers QA/QC FT-IR Resource CD L1050259 FT-IR Polymer QA/QC Resource License L1101018	L1608013

Environmental Hydrocarbons ASTM D7066-04 Application Pack

Contains accessories, consumables and application software to perform ASTM D7066-04 (extraction into hydrocarbon-free solvent and then transmission FT-IR). Includes cuvette holder, 10 mm quartz cuvette and Environmental Hydrocarbons Touch Application Software Kit.

Description	Part No.
Environmental Hydrocarbons ASTM D7066-04 Application Pack Pack includes: C2 Cuvettes, 10 mm, Quartz, Rectangular, with Stopper, B0631033 Cuvette Holder L1240055 EH ASTM Analysis Case L1608126 IR Environ Hydro Touch App S/W Kit LX108940	L1608006

Environmental Hydrocarbons Cyclohexane Application Pack

Contains accessories, consumables and application software to perform oil in water measurements by extraction into cyclohexane then transmission FT-IR. Includes two Port Luer Lock %T Cell – CaF₂ 0.5 mm, two 2 mL Luer lock Syringe, Spare 0.5 mm PTFE Spacer (pkg. 3), and Environmental Hydrocarbons Touch Application Software Kit.

Description	Part No.
Environmental Hydrocarbons Cyclohexane Application Pack Pack Includes: Plug Luer Fitting 04821008 2 mL Luer Syringe 04967845 Teflon Spacer, 0.5 mm (pkg. 3) L1270409 2 Port Luer Lock %T Cell – CaF ₂ 0.5 mm L1608122 IR Fuels Sampling Case L1608129 Torque Driver 24 cNm L9003631 Hex Bit 3.0 mm L9003632 IR Environ Hydro Touch App S/W Kit LX108940	L1608007

Environmental Hydrocarbons HATR Application Pack for Spectrum Two

Contains accessories, consumables and application software to perform oil in water measurements by ATR. Includes Spectrum Two HATR, ZnSe 45° Top plate – Flat, 25 µm micro pipette, pipette tips, and Environmental Hydrocarbons Touch Application Software Kit.

Description	Part No.
Environmental Hydrocarbons ATR Application Pack for Spectrum Two Pack includes: Spectrum Two HATR-Film Accessory L1600113 IR Environ Hydro Touch App S/W Kit LX108940	L1608008

In-Service Lubricants Application Pack

Contains accessories, consumables and application software to perform used oil analysis. Includes flow cell with ZnSe windows, wedged spacer and luer fittings for Used Oil Analyzer, 3 mL luer lock plastic syringe Starter (pkg. 100), Torque screwdriver, HEX BIT 3.0 mm, IR Liquid Cell Luer Connected Waste Tube, PTFE plugs (pkg. 6) plugs, and In-Service Lubricants Touch Application Software Kit.

Description	Part No.
In-Service Lubricants Application Pack Pack Includes: Used Oil Flow Cell L1272309 IR Liquid Cell Luer Connected Waste Tube L1608117 Syringe 3 mL Luer Lock – Plastic (pkg.100) L1608118 In-Service Lubricants Analysis Case L1608128 Torque Driver 24 cNm L9003631 Hex Bit 3.0 mm L9003632 In-Service Lubricants Touch App S/W Kit LX108939	L1608009

IR Biodiesel Application Pack

Contains accessories, consumables and application software to perform Biodiesel analysis using IR spectroscopy. Includes 2 Port Luer Lock %T Cell – BaF₂ 0.1 mm, 2 x 2 mL Luer lock Syringe, Assorted PTFE Spacers, Torque screwdriver, HEX BIT 3.0 mm, IR Liquid Cell Luer Connected Waste Tube, and Fuels FT-IR Touch Application Software Kit. Does not support ASTM D7371.

Description	Part No.
IR Biodiesel Application Pack Pack Includes: Plug Luer Fitting 04821008 2 mL Luer Syringe 04967845 Assorted Teflon Spacers L1270421 IR Liquid Cell Luer Connected Waste Tube L1608117 2 Port Luer Lock %T Cell – BaF ₂ 0.1 mm L1608121 IR Fuels Sampling Case L1608129 Torque Driver 24 cNm L9003631 Hex Bit 3.0 mm L9003632 IR Fuel Touch App S/W Kit LX108939	L1608010

IR Benzene in Gasoline ASTM D4053-04 Application Pack

Contains accessories, consumables and application software to measure Benzene in Gasoline by IR. Includes 2 Port Luer Lock %T Cell – KBr 0.025 mm, 2 x 2 mL Luer lock Syringe, Spare 0.025 mm PTFE Spacer (pkg. 5), Torque screwdriver, HEX BIT 3.0 mm, FT-IR Fuels Touch Application Software Kit.

Description	Part No.
IR Benzene in Gasoline ASTM D4053-04 Application Pack Pack Includes: Plug Luer Fitting 04821008 2 mL Luer Syringe 04967845 Rectangular Mylar Spacers 0.025 mm (pkg. 5) L1270401 2 Port Luer Lock %T Cell – KBr 0.025 mm L1608124 IR Fuels Sampling Case L1608129 Torque Driver 24 cNm L9003631 Hex Bit 3.0 mm L9003632 Quant + Addition Software Kit SP400 LX108911 IR Fuels Touch App S/W Kit LX108939	L1608012

Trans Fat Application Pack

The Trans Fat FT-IR Analysis Pack provides the necessary tools for the determination of the total isolated trans fat (as a percentage of total fat) of vegetable, animal, dairy, ruminant, and marine fats and oils by AOCS Cd 14e-09. Includes Pike MIRacle™ single reflection ZnSe ATR, heated ZnSe crystal plate, temperature controller, and Trans Fat FT-IR Touch Application Software kit.

Description	Part No.
Trans-Fat Application Pack Pack Includes: Trans Fat FT-IR Hardware Kit L1600117 IR Trans Fat Touch App S/W Kit LX108946	L1608015

FT-IR Educational Resource Pack

For teaching FT-IR Spectroscopy to students and new users. Includes 15 experiments that can be used as part of a training curriculum.

Description	Part No.
FT-IR Educational Resource Pack Pack Includes: FT-IR Educational Resource CD L1050246 IRTutor CD L1100998 1-User License for IR-Tutor L1101009 FT-IR Educational Resource Site License L1101010	L1608003

Spectral Libraries

Polymers

PerkinElmer provides a number of databases for the polymer endmarket, from PKI pre-built small libraries, which include plasticisers and raw materials, to a larger pre-built generic polymer library comprising over 5,500 spectra. The pre-built PKI libraries available include mid- and near-IR libraries.

Description	Part No.
ATR-IR – Polymers – Bio-Rad Sadtler	L1108717
IR – Coating Chemicals (Revised) – Bio-Rad Sadtler	N1873371
IR – Adhesives & Sealants (Subset) – Bio-Rad Sadtler	N1873300
IR – Polymer Processing Chemicals – Bio-Rad Sadtler Scholl	L1108723
IR – Rubber Chemicals (Revised) – Bio-Rad Sadtler	N1873321
IR – Polymer Additives (Revised) – Bio-Rad Sadtler	L1108727
IR – Polymer Processing Chemicals (Subset) – Bio-Rad Sadtler	L1108784
IR – Epoxy Resins, Curing Agents & Additives – Bio-Rad Sadtler	L1108734
IR – Plasticizers – Bio-Rad Sadtler	L1108745
IR – Polymers, Controlled Pyrolyzates – Bio-Rad Sadtler	L1108747
IR – Polymers & Monomers (Basic) 1 – Bio-Rad Sadtler	N1873302
IR – Polymers & Monomers (Subset) 1 – Bio-Rad Sadtler	N1873313
IR – Polymers, Hummel – Bio-Rad Sadtler	L1108721
IR – Polymers & Monomers (Subset) 2 – Bio-Rad Sadtler	N1873374
IR – Polymers & Monomers (Basic) 2 – Bio-Rad Sadtler	N1873369
IR – Electric Power Plant Materials – Bio-Rad Sadtler	L1108733
Polymer and Polymer Additives Library – T Spectra	L1108862
Polymers and Polymer Additives Library – A Spectra	L1108836
ST-Japan Polymer NIR Library	L1108926
ST-Japan Polymer Starter Pack	L1108924
Hazardous Chemicals Library – T Spectra	L1108877
Hazardous Chemicals Library – A Spectra	L1108851
Hazardous and Toxic Chemicals Library – T Spectra	L1108878
Hazardous and Toxic Chemicals Library – A Spectra	L1108852
Food Additives and Food Prepackaging Library – T Spectra	L1108863
Food Additives and Food Prepackaging Library – A Spectra	L1108837

Pharmaceuticals and Bio

PerkinElmer provides a number of databases for the pharmaceutical and bio end-markets, from PKI pre-built small generic libraries, which include drugs and raw material, to a larger pre-built generic pharmaceutical library comprising over 4,000 spectra.

Description	Part No.
Biochemicals Library – T Spectra	L1108866
Biochemicals Library – A Spectra	L1108840
Pharmaceuticals, Drugs & Antibiotics Library – T Spectra	L1108879
Pharmaceuticals, Drugs & Antibiotics Library – A Spectra	L1108853
ST-Japan Pharmaceutical NIR Library	L1108925
ST-Japan Pharma and Bio Starter Pack	L1108923

Forensics

PerkinElmer provides a number of databases for the forensics endmarket, from a PKI pre-built library, to libraries from third-party vendors (Bio-Rad and S.T. Japan). The PerkinElmer pre-built Forensics FT-IR spectral library contains over 3,000 mid-IR transmission spectra of various abused drugs, chemical compounds, fibers and polymers.

Description	Part No.
IR – Fibers & Textile Chemicals – Bio-Rad Sadtler	N1873305
IR – Canadian Forensics	N1873370
IR – Dyes – Bio-Rad Sadtler	N1873372
IR – Fibers by Microscope – Bio-Rad Sadtler	L1108778
IR – Automobile Paint Chips	L1108749
IR – Georgia State Crime Lab	N1873309
IR – Steroids 2 – Bio-Rad Sadtler	L1108735
IR – Dyes, Pigments & Stains – Bio-Rad Sadtler	L1108735
IR – Pharmaceuticals – Bio-Rad Sadtler	N1873316
IR – Prepared & Prescription Drugs (Acid) – Bio-Rad Sadtler/IR – Prepared & Prescription Drugs (Base) – Bio-Rad Sadtler	N1873319
IR – Flavors, Fragrances & Oils – Bio-Rad Sadtler	L1108779
ST – Japan forensic starter pack	L1108922
Forensic Library – T Spectra	L1108874
Forensic Library – A Spectra	L1108848
Dyes, Pigments and Stains Library – T Spectra	L1108875
Dyes, Pigments and Stains Library – A Spectra	L1108849
Hazardous Chemicals Library – T Spectra	L1108877
Hazardous Chemicals Library – A Spectra	L1108851
Hazardous and Toxic Chemicals Library – T Spectra	L1108878
Hazardous and Toxic Chemicals Library – A Spectra	L1108852

Chemicals

PerkinElmer provides a number of databases for the chemicals endmarket, from a PKI pre-built library, to libraries from third-party vendors (Bio-Rad and S.T. Japan). The PerkinElmer pre-built Chemicals FT-IR spectral library contains over 1,800 mid-IR transmission spectra of various chemical compounds, lubricants and organic solvents.

Description	Part No.
IR – Lubricants 1 – Bio-Rad Sadtler	L1108719
IR – Polyols – Bio-Rad Sadtler	N1873318
IR – Petroleum Chemicals – Bio-Rad Sadtler	N1873315
IR – Surfactants (Basic) – Bio-Rad Sadtler	L1108777
IR – Surfactants (Subset) 1 – Bio-Rad Sadtler	N1873325
IR – Surfactants (Subset) 2 – Bio-Rad Sadtler	N1873375
IR – Lubricant Additives 1 and 2 – Bio-Rad Sadtler/IR	L1108731
IR – Fats, Waxes & Derivatives – Bio-Rad Sadtler	L1108737
IR – Solvents – Bio-Rad Sadtler	L1108739
IR – Intermediates – Bio-Rad Sadtler	L1108741
IR – Standards (Vapor Phase Selected Subset) – Bio-Rad Sadtler	N1873376
IR – Intermediates (Basic) – Bio-Rad Sadtler	N1873311
IR – Merck – Bio-Rad Sadtler	L1108725
IR – Solvents (Basic) – Bio-Rad Sadtler	L1108781
ATR-IR – Solvents – Bio-Rad Sadtler	L1108782
IR – Solvents (Vapor Phase) – Bio-Rad Sadtler	L1108783
IR – Electric Power Plant Materials – Bio-Rad Sadtler	N1873323
IR – Gases & Vapors – Bio-Rad Sadtler	N1873308
IR – Pesticides & Agricultural Chemicals – Bio-Rad Sadtler	L1108780
IR – Priority Pollutants & Priority Pollutants (Vapor Phase)	N1873320
IR – EPA Vapor Phase – Bio-Rad Sadtler	N1873304
IR – Water Treatment Chemicals – Bio-Rad Sadtler	N1873327
IR – Inorganics – Bio-Rad Sadtler	N1873310
IR- Inorganics (Subset) – Bio-Rad Sadtler	L1108751
IR – Minerals & Clays – Bio-Rad Sadtler	N1873312
IR – Organometallics – Bio-Rad Sadtler	N1873314
Pesticides Library	L1108872
Pesticides Library	L1108846
Semiconductor Chemical Library – T Spectra	L1108873
Semiconductor Chemical Library – A Spectra	L1108847
High Production Volume Chemical Library – T Spectra	L1108880
High Production Volume Chemical Library – A Spectra	L1108854
Solvents Library – T Spectra	L1108864
Solvents Library – A Spectra	L1108838

Description	Part No.
Organometallics and Inorganics Library – T Spectra	L1108865
Organometallics and Inorganics Library – A Spectra	L1108839
Flavors, Fragrances and Cosmetic Ingredients Library – T Spectra	L1108871
Flavors, Fragrances and Cosmetic Ingredients Library – A Spectra	L1108845
Food Additives and Food Packaging Library – T Spectra	L1108863
Food Additives and Food packaging Library – A Spectra	L1108837
Sulfur and Phosphorous Library – T Spectra	L1108876
Sulfur and Phosphorous Library – A Spectra	L1108850
Aldehydes and Ketones Library – T Spectra	L1108867
Aldehydes and Ketones Library – A Spectra	L1108841
Alcohols and Phenols Library – T Spectra	L1108868
Alcohols and Phenols Library – A Spectra	L1108842
Esters, Lactones and Anhydrides Library – T Spectra	L1108869
Esters, Lactones and Anhydrides Library – A Spectra	L1108843
Hydrocarbons Library – T Spectra	L1108870
Hydrocarbons Library – A Spectra	L1108844

Other – General Purpose

General purpose transmission and ATR libraries from PerkinElmer are available which contain a compilation of mid-IR spectra of various materials of relevance to the fields of polymers, forensics and pharmaceuticals, for example. Additionally, PerkinElmer provides a larger general purpose library from Fiveash Data Management, Inc. which consists of around 29,000 ATR and transmission spectra for a wide range of materials.

Description	Part No.
FiveAsh Large Bundle	L1108932
SDBS KBr Database	L1108855
SDBS KBr Database, Volume 1	L1108856
SDBS KBr Database, Volume 2	L1108835
SDBS Liquid Film Database	L1108858
SDBS Nujol Database	L1108859
SDBS Nujol Database, Volume 1	L1108860
SDBS Nujol Database, Volume 2	L1108861
Aldrich Database	L1108830
IChem Database	L1108831
Aldrich-IChem Package Database	L1108832
Aldrich-IChem Database Supplement	L1108835

Perten & Delta Instruments



Falling Number

Internationally recognized standard method for alpha-amylase enzyme activity in grain and flour.

FN 1000

High capacity dual analysis system.

- Automatic water level control.
- Insulated water bath and lid.
- Automatic altitude correction when required.
- Capable of testing flours with added fungal alpha-amylase.
- Has 4 USB ports and one Ethernet port.

FN 1500

- Automatic single analysis system.
- Equipped with a control unit containing a printer, keypad and small display.
- RS-232 connection allows results to be automatically sent to a connected computer after analysis.

FN 1310

- Automatic single analysis system designed for efficiency.
- Exceptional instrument life.

Applications:

- Detect sprout damage in grain.
- Optimization of flour alpha-amylase activity.



Glutomatic® Systems

The world standard for gluten quantity and quality determination. When baking bread and producing noodles or pasta, the flour gluten content and strength will determine the quality of the finished product.

- Gluten Index (gluten quality) method works for both flour and ground wheat.
- Glutomatic System specifications are used in international wheat and flour trade.
- Performs complete test in under ten minutes.
- Complete system consists of Glutomatic 2200, the Gluten Index Centrifuge 2015 and the Glutork 2020 dryer.

Applications:

- Evaluate functional properties of protein already in the breeding of new wheat varieties.
- Classify the wheat and flour in trade and handling.
- Determine baking quality of wheat and flour.



RVA

An ideal tool for product development, process control, and quality assurance.

RVA 4800

- Performs tests at 140°C and below in a pressure vessel.
- Analyzes ingredient performance under aseptic conditions.
- High sensitivity for widest viscosity range: 10 cP-25,000 cP at 160 rpm.

RVA 4500

- High sensitivity for widest viscosity range: 10 cP-25,000 cP at 160 rpm.
- Performs tests below 100°C.

RVA-TecMaster

- Fully featured viscometer.
- Covers the mid viscosity range (20–8,000 cP at 160 rpm).

RVA-StarchMaster2

- Standalone (no computer/software required) economical viscometer.
- Covers the mid viscosity range (20–8,000 cP at 160 rpm).

Applications:

- Analyze viscous properties of starches, hydrocolloids and other food raw materials.
- Fingerprint the ideal ingredient and verifies quality from batch to batch.



TVT 6700

Dual load cell texture analyzer designed for the food industry.

- Greater sensitivity and reproducibility than traditional sensory testing.
- Capture data and export as a graph.
- Changing between the two load cells takes less than a minute.
- Standard and custom test options available.
- Robust design for laboratory or production environment.
- Large range of probes and rigs for food related applications.

Applications:

- Texture tests for hardness, adhesiveness, gumminess and more.
- Compressive and tensile strength testing.



doughLAB

Approved analysis methods for flour properties.

- Versatile operation with choice of traditional 20 minutes test, 10 minutes high speed mixing test and user defined methods.
- Programmable temperature to study dough performance during heating, cooling and gelling/cooking.
- Integrated and programmable bowl temperature control system.
- Automated water dispensing system.
- Virtual blending SW feature for flour mixing prediction.
- Complies with ISO9000 and Quality System requirements.

Applications:

- AACCI approved analysis of flour water absorption, dough development, and mixing tolerance.
- Analyze dough during heating, cooling, and gelling.
- Rapid mixing method for bake labs.
- Variable speed mixing to study stiff dough (for e.g. pasta) and crumble dough.



BVM 6600

AACCI approved volume measurement device based on laser topography.

- 20–30 second typical measurement time.
- Sample volume, dimensions, weight, and density are presented in table and shown on 3D graph.
- Faster and more accurate than the traditional speed displacement test.
- Non-contact measurement, can handle sticky and soft baked products.
- A range of support plates and hooks for different products to be tested.

Applications:

- Industrial bakeries quality assurance and control.
- Yeast and bake ingredient manufacturers.
- Flour mill test bakeries.



Perten & Delta Instruments



DA 7250 NIR

High performance diode array NIR instrument designed for the food and agriculture industries.

- 6 second analysis time.
- Wide range of available calibrations.
- Unique performance on unground or inhomogeneous samples.
- Easy sample handling; no need to clean cups between analyses.
- Touch screen operation of intuitive software.
- IP65 certified for dust and water resistance.
- Anytime access to results via web browser.
- Calibration transfer to continuous process analyzers.

Applications:

- Verification of raw materials composition, final product quality and process control.
- Determine moisture, protein, fat, ash, starch, fiber and other parameters.
- Ready to use calibrations for feed, pet foods, grains, oilseeds, cereal products, meat, dairy, snack foods and more.
- Analyze grains, flakes, pellets, powders, pastes, slurries, and liquids in their current form.



DA 7440 NIR

On-line diode array NIR sensor for over-the-belt type measurements.

- Automatic or manual process control with remote access.
- Track and document measurement results throughout the entire production run.
- Requires little or no adjustment at product change-overs or start-up.
- No moving optical components and housed in an ingress-protected housing which requires little maintenance.
- Uses industry standard open communication protocol, enabling remote access and true uniformation integration with existing plant systems.

Applications:

- Control food processes such as frying, drying and freezing.
- Determine moisture, nicotine and sugar content in leaves.
- Measure resin load and moisture in wood-based products.



DA 7300 NIR

In-line diode array NIR instrument.

- Automatic or manual process control with optional manual intervention.
- Provides real-time information about the product as it is produced, giving complete production traceability.
- Scratch resistant sapphire window.
- Industry standard communication interfaces.

Applications:

- Measure grains, pellets, granules, powders, and similar samples as they are conveyed through a process.
- Grain, flour, and feed processing industries.





DA 6200 NIR

Portable diode array transmission NIR instrument.

- Compact, low weight with up to eight hours of battery life.
- Easy-to-use touch screen, intuitive user interface.
- Analyze a large sample volume to ensure representative measurements.
- Straightforward sample handling using magnetically coupled cups.
- Equipped with factory meat and olive product calibrations that can be custom-updated upon request.

Applications:

- Verify raw materials within specification, save money in production and lower product variations.
- Analysis of semi-solid homogenized samples.
- Beef, pork and poultry raw meats, process samples and final products.
- Ground olives and olive pomace.
- Determine fat, moisture and protein composition.

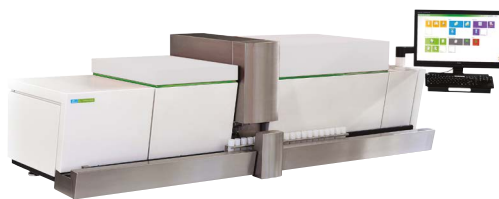

CombiScope

Multi-component 600 HP FT-IR dairy analyzer.

- Capable of analyzing up to 600 samples per hour, the highest sample throughput available for routine dairy analysis.
- Consists of a sample handling system, component analyzer (LactoScope FT-IR), and somatic cell counter (SomaScope LFC).
- Intelligent Diagnostic System (IDS) monitors and assesses system performance and alerts operator to hard-to-analyze samples.
- Simple Touch Screen operation allows for easy start-up data handling and transfer.

Applications:

- Analyze various types of milk, including cow, goat, sheep, and buffalo.



Lactoscope

Versatile mid-infrared analyzer capable of testing a wide range of dairy products.

This includes raw, standardized and processed milks, whey, and cream.

FT-A

- 30 second measurement time.
- Tests creams with 55% fat and other viscous products.
- Typical accuracy is under 1% CV.
- Low cost of ownership.
- Analyze fat, protein, lactose, and total solids and more in dairy products.

FT-B

- 45 second measurement time.
- For testing milks, whey and creams with up to 40% fat.

Applications:

- Analyze fat, protein, lactose, and total solids in dairy products.

Perten & Delta Instruments



Inframatic 9500

NIR instrument built to meet the requirements of grain handling operations.

- Robust design with modern electronics and precise optical components.
- Sealed module construction of standardized components guarantees long term reliability, making the instrument virtually maintenance free.
- Analysis time of less than 30 seconds.
- Wavelength calibration performed with NIST references to provide full traceability back to measurable standards.
- Uses NetPlus web-based platform for remote access and networking.
- Reliable, robust design using sealed module construction of standardized components.

Applications:

- Analyze a wide range of grains and oilseeds for moisture, protein, oil, and many other parameters.
- Ethanol production.



Inframatic 9520

Dedicated NIR instrument for flour and semolina.

- Uses NetPlus web-based platform for remote access and networking.
- Delivered with global calibrations for a wide variety of flour types.
- Secure analysis time of less than 30 seconds.
- Easily packed cuvette for operator-independent procedure.
- Sealed module construction of standardized components guarantees long term reliability, making the instrument virtually maintenance free.
- Rapid, secure user interface.

Applications:

- Milling degree optimization and monitoring.
- Analyze grain for moisture, protein, ash, and other key components.



Inframatic 8800

Portable NIR meter designed for farm conditions.

- Compact, easy-to-carry, and low-maintenance design.
- Automated shutter protects tester from light, insects, and vermin.
- Two-hour battery life (12–24 V).
- Equipped with a GPS to enable point-specific sampling and on-the-go field protein mapping.
- Comes with standard carrying bag for transport and storage.

Applications:

- Protein, moisture, and oil determination in grain and oilseed.
- Flour and oilseed milling.
- Ethanol production.
- Harvest and binning decisions.
- Grain measurement in-field, in storage locations, and at grain processing locations.



Aquamatic 5200

High frequency grain moisture meter.

- Uses second-generation 150 MHz technology, providing superior accuracy and repeatability.
- Can be used alone or integrated into automated testing systems.
- Measures moisture and hectoliter weight/test weight in 10 seconds. An optional flow-through allows for automated testing.
- Higher frequency for greater penetration of samples.
- Has a large color touch screen, which responds to gloved hands, and an intuitive user interface.

Applications:

- Ethanol production.
- Measure temperature, weight, and moisture content in grains, lentils, seeds, and more.



Laboratory Mill

Hammer Mills:

- Grinding grain to a fine homogeneous sample for e.g. Falling Number, Glutomatic, NIR and other analysis.

LM 3100

Hammer mill with robust metal construction built in and insulated for low noise level.

- Cyclone sample outlet for convenient sample collection.
- Virtually self-cleaning between grindings.

LM 120

Simple hammer mill with a robust metal construction and nylon bag for sample collection.

Disc Mills:

Grinders specifically designed for grain moisture analysis.

LM 3310

- Approved for oven and NIR moisture tests.
- Adopted by AACC standard method No. 55-30 to determine wheat hardness by PSI.
- Grinds samples up to 50 grams.

LM 3610

Approved for oven and moisture tests.

- Capable of grinding larger materials and sample sizes, such as raw feed and pellets up to 250 grams.



SPD

SPD 4200

Sequential Precision Divider, a single step divider for sub-sampling.

- Provides a 3.1% fully representative sub-sample in under 15 seconds.
- Simple, robust design with no moving parts or motors.
- Transparent divider sections to improve visibility and eliminate risk of cross-contamination.
- Exceptional instrument life and low cost of ownership.

Applications:

- Sub-sampling for mycotoxin testing.
- Visual grain inspection.
- Malt germination tests.







Accessories and Consumables for Perten DA 7250/DA 7200

Sample Presentation Accessories

	Description	DA 7250 Part No.	DA 7200 Part No.
	Large Sample Dish The Large Dish is the standard form of sample presentation for most samples. It maximizes analysis area for grains, pellets, meals, granules, flakes and other solids – 400 mL /US liquid oz. 13.5. (Ø 150 mm)	PER23562	PER720506
	Small Sample Dish Suitable for small sample volumes of homogeneous samples which do not require a large sample surface – 150 mL /US liquid oz. 5.1. (Ø 105 mm)	PER29693	PER720504
	Half-depth Dish The best results for heterogeneous samples are obtained when a large surface area is analyzed. The Half-depth Dish maximizes surface while minimizing sample volume requirements – 200 mL /US liquid oz. 6.8. (Ø 150 mm)	PER32761	PER723301
	Small Sample Cups (Set of 3) When only a small sample volume available, a Small Sample Cup is an excellent way to present the sample. It comes in a package of three cups with volumes of 13, 22 and 43 mL respectively (US liquid oz. 0.44, 0.73 and 1.47). For use in DA 7250 the Rotating Accessory Holder is required	PER729996	PER729996
	Micro Mirror Cup The Micro Mirror Cup is specifically designed for extremely small volumes of seed or powder. Its unique design enhances the signal from very small samples providing accurate analysis. An Accessory Tray is required for use in DA 7250 or 7200	PER721180	PER721180
	Disposable Cup Analyze slurries, pastes, molasses and other difficult sample types. Requires minimal sample handling and no clean-up. Requires an Accessory Tray for use in DA 7250 or 7200	PER720545	PER720545
	Transflectance Cup For analysis of liquids with low light absorbance, such as oils and other transparent non water-based liquids. Requires Accessory Tray and a pipette for 0-5 mL for use in DA 7250 or 7200	PER35201	PER35201
	Clear Liquid Cup with Filter Pad Designed for analysis of samples with high absorbance such as water based liquids. Requires Accessory Tray, Filter pads, and a pipette for 0-2 mL for use in DA 7250 or 7200	PER729984 (Cup) PER729981 (Filter pad)	PER729984 (Cup) PER729981 (Filter pad)
	Syrup Cup The Syrup Cup is designed for analysis of syrups and other high viscosity products. Requires Accessory Tray for use in DA 7250 or 7200	PER729970	PER729970
	Closed Quartz Cup The Closed Quartz Cup allows for analysis through a fused silica surface. While not as optimal as analyzing a sample in a non-contact, open-faced device, this cup is useful for users accustomed to analysis with closed cups. For use in DA 7250 the Rotating Accessory Holder is required	PER722002	PER722002
	Compression Plate For Large Dish Used for packing the sample surface of springy materials such as organic plant material	PER29233	PER29233
	Accessory Tray Required for use with many sample presentation accessories	PER26023	PER729979
	Rotating Accessory Holder Required in DA 7250 for certain accessories such as Small Sample Dishes	PER28104	PER28104
	Carrier with Disposable Aluminum Cup Transflectance measurement of low light absorbance materials in disposable cup. Use together with Accessory Tray. Does not fit DA 7200	PER27723 (Cup) PER30456 (Carrier)	PER27723 (Cup) PER30456 (Carrier)
	Petri Dish Carriers Rotating carrier disposable Petri Dishes. Large carrier for 140 x 21 mm dish, Small carrier for 90 x 16.2 mm dish. Only for use with DA 7250, does not fit DA 7200	PER32458 (Large carrier) PER31869 (Small carrier)	PER32458 (Large carrier) PER31869 (Small carrier)
	Aluminium Dish Holder Transflectance measurements of hot oils in disposable cup	PER729952 (cups) PER729951 (holder)	PER729952 (cups) PER729951 (holder)



Other Accessories

	Description	DA 7250 Part No.	DA 7200 Part No.
	Barcode Reader Enter sample information expressed as bar codes automatically into the DA 7250 and 7200	PER723321 (1D) PER729960 (2D)	PER723321 (1D) PER729960 (2D)
	Stylus Pen For Touch Screen For operation of instrument through the touch screen	PER36361	PER36361
	Sample Preparation Tray Convenient for filling sample into dishes	PER29542	PER29542
	Reference Check Cell The Reference Check Cell is an inert, stable material that provides a method to monitor instrument stability over time. Requires an Accessory Tray for use in the 7200	PER31512	PER24229

Consumables

	Description	DA 7250 Part No.	DA 7200 Part No.
	Disposable Cups Use Together with Accessory Tray	PER720545 (Set of 250) PER729978 (Set of 2400)	PER720545 (Set of 250) PER729978 (Set of 2400)
	Filter Pads (Set of 100) Filter Pads for the Clear Liquid Cup	PER729981	PER729981
	Disposable Aluminium Cups (Set of 100) Use Together with Carrier and Accessory Tray	PER27723	PER27723
	Petri Dishes Use Together with Petri Dish Carriers Large Dish, 140 x 21 mm (set of 176), Small Dish, 90 x 16.2 mm (set of 480)	PER24529 (Large set of 176) PER25435 (Small set of 480)	PER24529 (Large set of 176) PER25435 (Small set of 480)
	Filter For Fan For DA 7200. DA 7250 does not have a Cooling Fan	PER721032	PER721032
	Spare Lamp User Exchangeable Spare Lamp	PER23313	PER723230

Software

	Description	DA 7250 Part No.	DA 7200 Part No.
	NetPlus NetPlus is an extensive reporting and networking web-based software platform for accessing analysis results as well as networking and remote handling of multiple instruments	PER35120 PER35121 NetPlus Remote	PER35120 NetPlus Reports PER35121 NetPlus Remote
	The Unscrambler X Software for Calibration Development for DA 7250 and 7200. Created by Camo A/S, Norway	PER708820	PER708820

UV/VIS

PerkinElmer offers a wide selection of superior quality products designed to work with your PerkinElmer instruments. Our precision designed products deliver the peace of mind that comes from knowing that you'll get the results you need.

Quick Reference Index Page

UV/Vis Lamps

PerkinElmer supplies high-quality, long-lasting Xenon, Deuterium and Tungsten source lamps for all of their UV/Vis spectrometers. For optimal instrument performance, always use original replacement lamps from PerkinElmer.



UV/Vis Cells

PerkinElmer's UV/Vis cells come in many shapes, sizes, pathlengths, and materials. They are designed to make full use of the accuracy and sensitivity of your spectrometer. From macro to ultra-micro cells, short path to long path, high-quality Quartz to PTFE, you will find the cells you need here.



UV/Vis Reference Standards

PerkinElmer provides a variety of UV/Vis reference standards to ensure the measurement accuracy of your LAMBDA instruments. PKI recommends periodic recalibration/recertification.



Fiber Optic Probes and Accessories

PerkinElmer provides fiber optic probes for most of LAMBDA spectrometers. These probes are durable, come with tips of various path lengths, and are easy to clean.



Integrating Spheres

PerkinElmer offers a range of "snap-in", high-performance integrating spheres and extends their capabilities with a variety of sample holders and kits that support reliable, reproducible reflectance measurements.



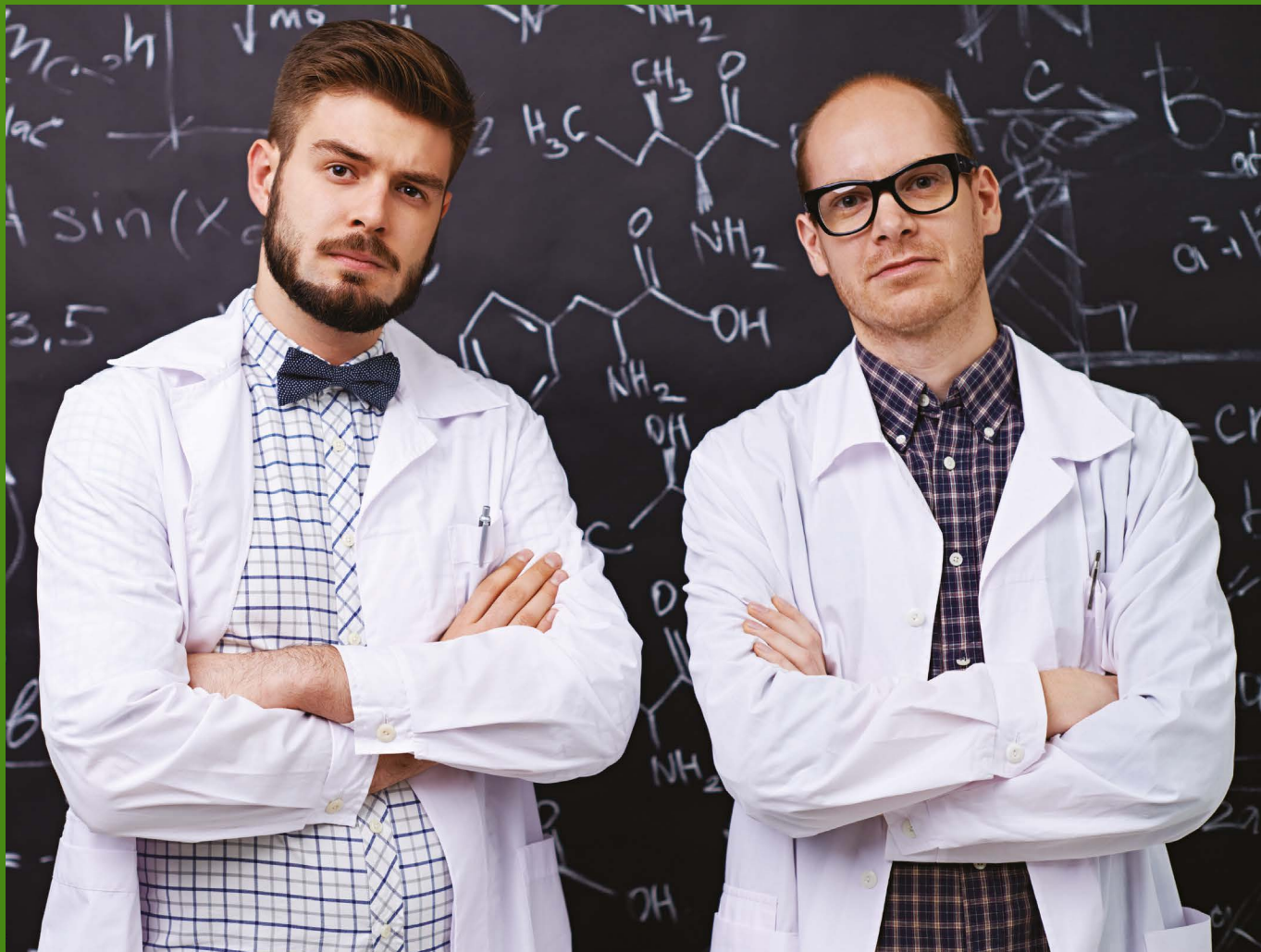

UV/VIS SOLUTIONS FOR CHALLENGES GREAT AND SMALL

PerkinElmer's family of industry-leading LAMBDA® UV/Vis spectrophotometers delivers the performance, sampling flexibility, and ease of use you need for meeting today's application challenges and developing the products of tomorrow. From compact, mobile systems to high-performance benchtop instrumentation, we have the complete solutions for all your UV/Vis requirements.



LAMBDA HP 850+ and 1050+/265/365/465 UV/Vis

JCANO INGENIERIA DE MÉXICO:
Priv. Brunel Mz. 1 Lt. 5 Cs 4-B Fracc. Quinta Versalles
C.P. 55767 Tecámac, Edo. De México
Correo: mcano@jcanoingenieria.com
Página Web: <https://jcanoingenieria.com>
Tel: 55 3996 2586
WhatsApp: 55 7129 9832
Facebook: <https://www.facebook.com/JCanoIngenieria>



UV/Vis Instruments



LAMBDA XLS+/Bio+ UV/Vis

Personal UV/Vis Spectrophotometers for routine laboratory needs. Built in Bio methods but limited to 10 mm cuvette.

Standalone (no computer required).

Spectral bandwidth of 3 nm.

Features:

- Small footprint with large LCD screen and full scanning capabilities.
- No moving parts and virtually no maintenance.
- Xenon light source and innovative polychromator technology provide continuous reliability.
- Ultra-fast initialization that requires no warm up time and can analyze a full range of spectra in less than 3 seconds.
- Split beam design avoids instrument drift from excess heat.
- Wavelength range of 190–1100 nm with a scanning range of 200–950 nm.
- Calibration is automatic when the instrument is turned on.
- Built-in USB port and optional integrated thermal printer, optional bluetooth.
- Up to 8 instruments can be connected to a single PC automatically collect and display data.
- Convenient sampling flexibility allows samples to be measured in glass, quartz, or disposable cells in pathlengths of 10 nm, 20 nm, or 40 nm.
- Bio+ includes 10 preprogrammed methods for DNA, RNA, Oligonucleotides, and Protein analysis.
- Capacity to store up to 90 user-developed methods.

Applications:

- Routine analysis.
- Life Science and Analytical Teaching labs.
- QA/QC.



LAMBDA 265 UV/Vis

Fast, easy-to-use, affordable photodiode array PDA single-beam UV/Vis.

- Photodiode array detector that enables data to be acquired simultaneously across the full wavelength range, from 190–1100 nm.
- Compact size with no moving parts and easy-to-use software.
- High-energy Xenon flash lamp that is only active while spectrum is being acquired.
- Can be combined with an autosampler for method development and sample analysis.
- Accommodates a variety of accessories including film holders, variable pathlength cells, and sippers.

Applications:

- Routine analysis in research and development environmental laboratories.



LAMBDA 365 UV/Vis

Compact, versatile, and easy-to-use double-beam UV/Vis.

- Delivers a variable spectral bandwidth capability from 0.5–20 nm.
- Variable angle transmission accessory available.
- Accommodates a variety of accessories including optical fiber probes, integrating spheres, and base plate adapter for legacy LAMBDA accessories.
- Wavelength Range 190–1100 nm.
- Can be combined with an autosampler for method development and sample analysis.
- Flexible Resolution (0.5–1.0).
- Superior for Peak Resolutions.
- 21 CFR Part 11 and EU Annex 11 compliance Software.
- Numerous accessories available to support a wide range of sample types and conditions, see the following pages for more details.

Applications:

- Standard methods and applications.
- Pharmaceuticals, analytical chemistry, genetics, and manufacturing QA/QC analysis.
- Methods and applications requiring regulatory compliance.



LAMBDA 465 UV/Vis

Ultrafast, high-performance, reliable photodiode array PDA single-beam UV/Vis.

- Ultra Fast Scans; allows the acquisition of a full spectrum (from 190–1100 nm) in as little as 20 msec.
- System has 1 nm resolution to meet the requirements of many pharmacopoeias.
- Variable angle transmission, optical fiber probe, and diffuse reflectance accessories available.
- Can be combined with an autosampler for method development and sample analysis.
- Provides the highest-energy throughput possible.
- Dual Light Source.
- Open Compartment – enables transmittance analysis without cutting off above samples and easier sample and accessory handling.
- Has the capability to display more than 20 wavelengths simultaneously.
- Superior for:
 - Fast Reactions.
 - Kinetics Reactions.
 - Sample flexibility (open compartment).
 - Measuring all wavelengths simultaneously.
- 21 CFR Part 11 and EU Annex 11 compliance Software.
- Numerous accessories available to support a wide range of sample types and conditions, see the following pages for more details.

Applications:

- Rapid reactions, such as those in chemical, Life Science, Biochemistry and biochemical analysis.
- Chemical, Dye, Glass, Film, & Optics.
- Dissolution, fast kinetics, and other applications where high-speed scanning and high resolution are required.

High Performance UV/Vis & UV/Vis-NIR



LAMBDA 850+ UV/Vis

Equipped with state-of-the-art, gridless PMT detector, ideal for companies and products that only require UV/Vis testing capabilities.

- Large, dual sample compartments.
- Universal reflectance, snap-in integrating spheres, and general-purpose optical bench accessories are available.
- Excellent sensitivity between 175 nm and 900 nm with resolution up to 0.05 nm.
- Universal reflectance accessory with Si detector for automated, precise, and reproducible angle adjustments.
- Internal instrument controlled attenuation from 1–0.1% for high absorbing measurements.
- 21 CFR Part 11 and EU Annex 11 compliance Software.

Applications:

- Cosmetic and sun products involving the protection from UV rays.
- Color, brightness, viewing angle, and power consumption of flat panel displays.
- Color analysis of paints and textiles, turbid solutions, and enzyme kinetics in life science, biochemistry, and pharmaceutical laboratories.
- Solar energy research, specifically silicon-based solar cells.



LAMBDA 1050+ UV/Vis-NIR

The LAMBDA 1050+ can be used for high precision measurements UV/Vis-NIR, and for applications such as highly reflective and anti-reflective coatings, color correction coatings, bandpass characteristics filters and much more.

Applications

- High absorbing glass.
- Optical coatings with less limitations in the NIR range.
- Fiber optic filters including narrow band optical filters.
- Nanomaterials in optical, non-optical, renewable energy, and advanced polymer design.

LAMBDA 1050+ is available:

- No detector.
- Two Detectors (2D), PMT and PBS.
- Three Detectors (3D) PMT, PBS and InGaAS.

Specifications	1050+ (2-Detector)	1050+ (3-Detector)
Spectral range, up to 3300 nm	√	√
UV/Vis resolution up to 0.05 nm	√	√
NIR resolution up to 0.20 nm	√	√
Gridless PMT Detector containing a Peltier-controlled PbS Detector	√	√
InGaAs Detector	(OA)	√
Internal instrument-controlled attenuation from 1% to 0.1% for high absorbing measurement	√	√
Large, dual sample compartments	√	√
1%, 0.1% Reference and Sample Beam attenuation enable high absorbance measurements	√	√
Universal reflectance accessory UV/Vis-NIR with dual Si and PbS detectors for automated, precise, and reproducible angle adjustments	(OA)	(OA)
Snap-in PbS Integrating Spheres (60, 100, & 150 nm) with 8" reflectance and center mount capability	(OA)	(OA)
Snap-in In GaAs Integrating Spheres (100, 150 & 270 nm) with 8" reflectance and center mount capability	(OA)	(OA)
Total Absorbance Measuring System for (a) Absolute measurement of Directional Reflectance & Transmittance and (b) BRDF/ BTDF measurements (characterization of the appearance of surfaces)	(OA)	(OA)
General-Purpose Optical Bench	(OA)	(OA)
21 CFR Part 11 and EU Annex 11	(OS)	(OS)

√ Included (OA) Optional Accessory (OS) Optional Software



Accessories and Replacement Parts for High Performance Instruments

Description	Part No.
Optical Breadboard Base Plate, Sample Compartment Optional replacement for standard sample floor	N1016002
Sample Compartment Windows Included with LAMBDA 650/750/850/850+/950/1050/1050+ spectrometer systems. Requires four windows	B0505982
Reference Beam Attenuator Kit Includes 5 magnetically mounted attenuator screens, 32%, 14%, 6%, 4% and 1% T	L1160560
Magnetic Attenuator, 10% Used to provide additional attenuation when measuring high absorbance materials	L6020277
Magnetic Attenuator, 1% Used to provide additional attenuation when measuring high absorbance materials	L6020276

UV/VIS Lamps

For optimal instrument performance always use original replacement sources from PerkinElmer. Replacement lamps are available for all PerkinElmer spectrometers. Some lamps can be self-installed; others, a service call is recommended.



LAMBDA 265/365/465 Source Lamps

Xenon Source Lamp

The high-energy Xenon flash lamp provides consistently high performance for years of worry-free operation.

Deuterium and Tungsten Source Lamps

PerkinElmer's long-lifetime deuterium and tungsten source lamps provide the wavelength coverage across the working range of the spectrometer for consistently high performance. All lamps are pre-aligned and can be easily changed by the user. Our quality control and inspection processes demand the best quality sources, ensuring high sensitivity and stability for your key measurements.

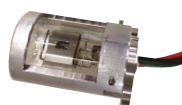

Deuterium Lamp for LAMBDA 365 **N4101036**



Tungsten Lamp for LAMBDA 365 **N4101037**

LAMBDA Model	Xenon Part No.	Deuterium Part No.	Tungsten-halogen Part No.
265	N4103008*		
365		N4101036	N4101037
465		N4104016	N4104017

* PKI recommends that this lamp be replaced by a PerkinElmer Service Engineer.

Source Lamps for High Performance Models

The LAMBDA 850+ and 1050+ spectrometers come with long-lasting Deuterium and Tungsten lamps. Both lamps are pre-aligned for easy installation and have an automatic source change indicator. The LAMBDA 1050+ includes a source collection mirror to support increased Vis/NIR energy.



Long Life Deuterium lamp and Hours Meter **L6022728**



Tungsten-halogen lamp **B0114620**

LAMBDA Model	Deuterium Part No.	Tungsten-halogen Part No.
LAMBDA 850+/1050+	L6022728	B0114620

Other LAMBDA Spectrometer Lamps

For legacy LAMBDA spectrometers, PerkinElmer supplies reliable, long lasting deuterium and tungsten-halogen light sources. We recommend these replacement bulbs be installed by a PerkinElmer Service Engineer since optimal spectrometer performance depends upon the lamp's precise alignment.

LAMBDA Model	Deuterium Part No.	Tungsten-halogen Part No.
LAMBDA 1/3	C0550505	C0550500
LAMBDA 4/6	B0114615*	B0114620
LAMBDA 5/7/9	B0114615*	B0114620
LAMBDA EZ 301	C6957776	C6957775
Visible Source Lamp, LAMBDA EZ 150/201/210		C6957528
UV Source Lamp, LAMBDA EZ 150/201/210	C6957529	
2/12/14/14P/10/10 Bio/20/ 20 Bio/40/40 Bio/40P/650/750/ 800/850/850+/900/950/1050/1050+	L6022728	B0114620

* This Deuterium lamp comes with a cable adapter (**B0166354**).

Replacement Polarimeter Lamps

These replacement lamps are for older Polarimeter models. PerkinElmer recommends a service visit to replace, align, and ensure optimal lamp operation.



Sodium Spectral Lamp **L9004741**

Description	Part No.
Sodium Spectral Lamp, 20 W, Polarimeter 241/243/341/343	L9004741
HG-Lamp ST46, Polarimeters 341	B0510581

UV/Vis Cells

PerkinElmer Cells Ensure Top Optical Performance, with High Cell Transmission and Accurate Pathlength

No matter what type of cells your application requires – rectangular or cylindrical, standard or short path, micro, semi-micro or flow-through cells – choosing only high quality, precision cells allows you to make full use of the accuracy and sensitivity of your spectrometer.

Our cells are manufactured from three types of material. Special Optical Glass, SUPRASIL® UV Quartz and SUPRASIL 300 NIR Quartz, in all the common sizes and types. The most important criterion when choosing a cell is the material/spectral range for which the cell is intended. Color logos, fused on to each PerkinElmer cell, indicate the cell spectral range.

Macro Cells with PTFE Lid

Standard rectangular macro cells are the most frequently-used cell for routine liquids analysis. Each cell has a standard inside width of 9.5 mm and a base thickness of 1.5 mm.

Lightpath	Outside Dim. H x W x D	Cell Volume	Qty.	Part No.
NIR Quartz SUPRASIL 300				
1 mm	45 x 12.5 x 3.5 mm	350 µL	2	B0631013*
5 mm	45 x 12.5 x 7.5 mm	1.75 mL	2	B0631014
10 mm	45 x 12.5 x 12.5 mm	3.5 mL	2	B0631015
20 mm	45 x 12.5 x 22.5 mm	7.0 mL	2	B0631016
50 mm	45 x 12.5 x 52.5 mm	17.5 mL	1	B0631017
100 mm	45 x 12.5 x 102.5 mm	35.0 mL	1	B0631018
Quartz SUPRASIL				
1 mm	45 x 12.5 x 3.5 mm	350 µL	2	B0631007*
5 mm	45 x 12.5 x 7.5 mm	1.75 mL	2	B0631008
10 mm	45 x 12.5 x 12.5 mm	3.5 mL	2	B0631009
20 mm	45 x 12.5 x 22.5 mm	7.0 mL	2	B0631010
50 mm	45 x 12.5 x 52.5 mm	17.5 mL	1	B0631011
100 mm	45 x 12.5 x 102.5 mm	35.0 mL	1	B0631012
Special Optical Glass				
1 mm	45 x 12.5 x 3.5 mm	350 µL	2	B0631001*
5 mm	45 x 12.5 x 7.5 mm	1.75 mL	2	B0631002
10 mm	45 x 12.5 x 12.5 mm	3.5 mL	2	B0631003
10 mm (no lid)	45 x 12.5 x 12.5 mm	3.5 mL	4	B0613134
20 mm	45 x 12.5 x 22.5 mm	7.0 mL	2	B0631004
50 mm	45 x 12.5 x 52.5 mm	17.5 mL	1	B0631005
50 mm	46 x 12.5 x 52.5 mm	17.5 mL	1	B0631023
100 mm	45 x 12.5 x 102.5 mm	35.0 mL	1	B0631006

* Glass lid.

SUPRASIL 300 NIR Quartz 200–3,500 nm

Indicates a synthetic quartz that is free from OH absorption. SUPRASIL 300 gives a transmission of more than 80% over a spectral range of between 200 nm and 3,500 nm for an empty cell. SUPRASIL 300 cells are identified by the red PerkinElmer logo.



SUPRASIL UV 300 Cell with Lid

SUPRASIL UV Quartz 200–2,500 nm

Indicates cells made from quartz of the highest purity and homogeneity. Sometimes called synthetic quartz, SUPRASIL Quartz cells give transmission values of more than 80% over a spectral range of 200–2,500 nm for an empty cell. SUPRASIL Quartz cells are identified by the blue PerkinElmer logo.



SUPRASIL UV 300 Cell with Stopper

Special Optical Glass 320–2,500 nm

Indicates cells made from SCHOTT type UK 5 glass. Made from exceptionally pure raw materials, Special Optical Glass cells offer a transmission of more than 80% over a spectral range of 320–2,500 nm for an empty cell. These cells are identified by the green PerkinElmer logo.

Macro with PTFE Stopper

The outside dimensions of Macro cells with PTFE Stoppers can differ from the Macro Cells with PTFE Lid. Their lightpaths and cell volumes, however, are the same.

Lightpath	Outside Dim. H x W x D	Cell Volume	Qty.	Part No.
NIR Quartz SUPRASIL 300				
1 mm	52 x 12.5 x 3.5 mm	350 µL	2	B0631031
5 mm	46 x 12.5 x 7.5 mm	1.75 mL	2	B0631032
10 mm	46 x 12.5 x 12.5 mm	3.5 mL	2	B0631033
20 mm	46 x 12.5 x 22.5 mm	7.0 mL	2	B0631034
50 mm	46 x 12.5 x 52.5 mm	17.5 mL	1	B0631035
100 mm	46 x 12.5 x 102.5 mm	35.0 mL	1	B0631036
Quartz SUPRASIL				
1 mm	52 x 12.5 x 3.5 mm	350 µL	2	B0631025
5 mm	46 x 12.5 x 7.5 mm	1.75 mL	2	B0631026
10 mm	46 x 12.5 x 12.5 mm	3.5 mL	2	B0631027
20 mm	46 x 12.5 x 22.5 mm	7.0 mL	2	B0631028
50 mm	46 x 12.5 x 52.5 mm	17.5 mL	1	B0631029
100 mm	46 x 12.5 x 102.5 mm	35.0 mL	1	B0631030
Special Optical Glass				
1 mm	48 x 12.5 x 3.5 mm	350 µL	2	B0631019
5 mm	46 x 12.5 x 7.5 mm	1.75 mL	2	B0631020
10 mm	46 x 12.5 x 12.5 mm	3.5 mL	2	B0631021

Semi-Micro Cells

Semi-micro cells have the same outside dimension as the macro cells but the cell walls have been thickened slightly, limiting the interior sample chamber width to 4 mm. Each cell has a base thickness of 3.2 mm and each package contains two cells with two clear windows each.

Semi-micro with PTFE Lid – Black Sides

Lightpath	Outside Dim. H x W x D	Cell Volume	Part No.
NIR Quartz SUPRASIL® 300			
10 mm	45 x 12.5 x 12.5 mm	1.4 mL	B0631051
Quartz SUPRASIL			
5 mm	45 x 12.5 x 7.5 mm	700 µL	B0631048
10 mm	45 x 12.5 x 12.5 mm	1.4 mL	B0631049
Special Optical Glass			
5 mm	45 x 12.5 x 7.5 mm	700 µL	B0631046
10 mm	45 x 12.5 x 12.5 mm	1.4 mL	B0631047

Semi-Micro with PTFE Lid – Clear Sides

Lightpath	Outside Dim. H x W x D	Cell Volume	Part No.
NIR Quartz SUPRASIL 300			
20 mm	45 x 12.5 x 22.5 mm	2.8 mL	B0631045
Quartz SUPRASIL			
20 mm	45 x 12.5 x 22.5 mm	2.8 mL	B0631042
Special Optical Glass			
20 mm	45 x 12.5 x 22.5 mm	2.8 mL	B0631039

Semi-Micro with PTFE Stopper – Black Sides

Lightpath	Outside Dim. H x W x D	Cell Volume	Part No.
NIR Quartz SUPRASIL 300			
10 mm	46 x 12.5 x 12.5 mm	1.4 mL	B0631066
Quartz SUPRASIL			
10 mm	46 x 12.5 x 12.5 mm	1.4 mL	B0631064

Semi-Micro with PTFE Stopper – Clear Sides

Lightpath	Outside Dim. H x W x D	Cell Volume	Part No.
NIR Quartz SUPRASIL 300			
20 mm	46 x 12.5 x 22.5 mm	2.8 mL	B0631060
Quartz SUPRASIL			
10 mm	46 x 12.5 x 22.5 mm	1.4 mL	B0631062
20 mm	46 x 12.5 x 22.5 mm	2.8 mL	B0631057

Micro Cells

Micro cells have the same outside dimension as the macro cells but the cell walls have been thickened, limiting the interior sample chamber width to 2 mm. Each cell has a standard light path of 10 mm and each package contains two cells. All micro cells listed have black side walls and base.



Micro with PTFE Lid

Outside Dim H x W x D (mm)	BaseThickness	Cell Volume	Part No.
Quartz SUPRASIL			
45 x 12.5 x 12.5 mm	3.2 mm	700 µL	B0631071
Special Optical Glass			
45 x 12.5 x 12.5 mm	3.2 mm	700 µL	B0631070

Micro with PTFE Stopper

Outside Dim H x W x D (mm)	BaseThickness	Cell Volume	Part No.
Quartz SUPRASIL			
40 x 12.5 x 12.5 mm	1.5 mm	400 µL	B0631077
Special Optical Glass			
40 x 12.5 x 12.5 mm	1.5 mm	400 µL	B0631076

Ultra-Micro Cells

Ultra-micro cells use a narrower sample chamber, raising it directly into the center of the light path and masking it with black quartz. All ultra micro cells contain one cell with two clear windows and have outside dimensions of 40 x 12.5 x 12.5 mm.

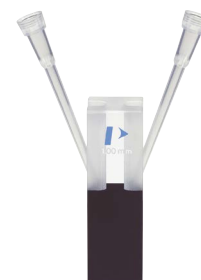

Ultra-Micro with PTFE Lid

Lightpath	Aperture	Chamber Volume	Part No.
Quartz SUPRASIL			
10 mm	2 x 1.5 mm	30 µL	B0631079

Ultra-Micro with Pipette Tips

Lightpath	Aperture	Chamber Volume	Part No.
Quartz SUPRASIL			
0.1 mm	1 x 5 mm	0.5 µL	B0631082
1 mm	1 x 5 mm	5 µL	B0631083
5 mm	Ø 0.8 mm	2.5 µL	B0631080
10 mm	Ø 0.8 mm	5 µL	B0631081



TrayCell in LAMBDA Bio+

TrayCell™

The TrayCell is a 1 cm x 1 cm fiber-optic ultramicro measuring cell designed for the UV/Vis analysis of DNA/RNA and proteins. The dimensions of the TrayCell are equivalent to a standard cuvette in order to work in most spectrophotometers and 15 mm should be used for all PerkinElmer UV/Vis spectrophotometers.



Features and Benefits:

- Suitable for almost any current spectrophotometers
- Ideally suited for very small measurement volumes: 0.7–10 µL
- Trouble-free measurement of the sample at different optical path lengths simply by exchanging the cap [caps with dilution factors: 5, 10, 50 and 100]
- Fast and simple cleaning of the optics before measuring the next sample – the TrayCell remains in the cell holder!
- Samples can be reused after the measurement simply by pipetting them off
- During measurements, TrayCell shows excellent reproducibility

Description	Part No.
UVS TrayCell complete with 0.2 mm and 1.0 mm caps. Complete with blocks to change beam height from 8.5 mm to 15 mm to 20 mm	L7110289
2.0 mm TrayCell, (Factor* 5) cap	L7110290
1.0 mm TrayCell, (Factor* 10) cap	L7110291
0.2 mm TrayCell, (Factor* 50) cap	L7110292
2 mm TrayCell, (Factor* 100) cap	L7110293

Caps for TrayCell

Description	Volume	Part No.
1 mm (Factor* 10)	3–5 µL	L7110291
0.2 mm (Factor* 50)	0.7–4 µL	L7110292
2 mm (Factor* 5)	6–10 µL	L7110290
0.1 mm (Factor* 100)	0.7–3 µL	L7110293

* Factor = dilution factor compared to a standard cell with a path length of 10 mm.

Nano Sticks

Each Nano Stick standard package kit with case comes with 1 Nano Stick, 1 loading plate, 1 bubble checker, and a user guide. You can select your choice of color: black, blue, red, gold, or silver.



Nano Sticks for LAMBDA 265

- The Nano Stick's Z-Dimension, or the height of the center of the light beam, differs is at 8.5 mm. The beam pathlength is 0.5 mm, and fits standard 10 mm cell holders.
- The D Nano Sticks have dual sampling ports.
- S Nano Sticks have a single sampling port.

Description	Color	Volume	Pathlength	Part No.
Nano Stick-D, Z 8.5	Black	2 µL	0.5 mm	N4101043
Nano Stick-D, Z 8.5	Blue	2 µL	0.5 mm	N4101044
Nano Stick-D, Z 8.5	Red	2 µL	0.5 mm	N4101045
Nano Stick-D, Z 8.6	Gold	2 µL	0.5 mm	N4101046
Nano Stick-D, Z 8.7	Silver	2 µL	0.5 mm	N4101047
Nano Stick-S, Z 8.8	Black	2 µL	0.5 mm	N4101038
Nano Stick-D, Z 8.9	Blue	2 µL	0.5 mm	N4101039
Nano Stick-D, Z 8.10	Red	2 µL	0.5 mm	N4101040
Nano Stick-D, Z 8.11	Gold	2 µL	0.5 mm	N4101041
Nano Stick-D, Z 8.12	Silver	2 µL	0.5 mm	N4101042

Nano Sticks for LAMBDA 365/465

- The Nano Stick's Z-Dimension, or the height of the center of the light beam, differs at 15 mm. The beam pathlength is 0.5 mm, and fits standard 10 mm cell holders.
- The D Nano Sticks have dual sampling ports.
- S Nano Sticks have a single sampling port.



Description	Color	Volume	Pathlength	Part No.
Nano Stick-D, Z 15	Black	2 µL	0.5 mm	N4101020
Nano Stick-D, Z 15	Blue	2 µL	0.5 mm	N4101021
Nano Stick-D, Z 15	Red	2 µL	0.5 mm	N4101022
Nano Stick-D, Z 15	Gold	2 µL	0.5 mm	N4101023
Nano Stick-D, Z 15	Silver	2 µL	0.5 mm	N4101024
Nano Stick-S, Z 15	Black	2 µL	0.5 mm	N4101031
Nano Stick-S, Z 15	Blue	2 µL	0.5 mm	N4101032
Nano Stick-S, Z 15	Red	2 µL	0.5 mm	N4101033
Nano Stick-S, Z 15	Gold	2 µL	0.5 mm	N4101034
Nano Stick-S, Z 15	Silver	2 µL	0.5 mm	N4101035

Flow-Through Cells

Flow-through cells are used for measuring samples with continuous flow or with sSippers where individual samples are aspirated into the cell. All cells have center heights of 15 mm.



Each package contains one cell with two clear windows. The cells listed below are compact with two screw connectors, M6 x1 and 500 mm length FEP tubing – 1.9 mm OD, 1.1 mm ID.

Material	Lightpath	Centre Height	Outside Depth	Aperture	Cell Volume	Part No.
Quartz SUPRASIL	1 mm	15 mm	35 x 12.5 x 12.5 mm	17.5 x 3.5 mm	62 µL	B0631085
Quartz SUPRASIL	10 mm	15 mm	35 x 12.5 x 12.5 mm	11 x 3.5 mm	390 µL	B0631084
Quartz SUPRASIL	10 mm	15 mm	35 x 12.5 x 12.5 mm	8 x 2 mm	160 µL	B0631087
Quartz SUPRASIL	10 mm	15 mm	35 x 12.5 x 12.5 mm	11 x 2.5 mm	300 µL	B0631150
Quartz SUPRASIL	10 mm	15 mm	35 x 12.5 x 12.5 mm	Ø 3 mm	80 µL	B0631089
Quartz SUPRASIL	50 mm	15 mm	45 x 12.5 x 52.5 mm	Ø 3 mm	370 µL	B0631088
Quartz SUPRASIL	10 mm	15 mm	35 x 12.5 x 12.5 mm	Ø 2 mm	30 µL	B0631090
Quartz SUPRASIL (FIAS)	10 mm	15 mm	35 x 12.5 x 12.5 mm	Ø 1.5 mm	18 µL	B0631151
Quartz SUPRASIL (FIAS)	10 mm	15 mm	35 x 12.5 x 12.5 mm	Ø 1 mm	8 µL	B0631152

Cylindrical Cells

Cylindrical cells have an outside diameter of 22 mm, an inside diameter of 19 mm, and a PTFE Stopper. Each package contains one cell with two windows. Requires the Cylindrical Path Cell Holder (**B0082539**).



Cylindrical Cell
B0631099

Flow Through Replacement Tubing

Description	Part No.
FEP-Replacement Tubing with one short screw fitting, 500 mm long	B0631130
FEP-Replacement Tubing with one long screw fitting, 500 mm long	B0631131
Sipper Tubing to Cuvette (in)	B2500129
Sipper Tubing to Cuvette (out)	B2500127

Cylindrical Cell Stoppers

Description	Part No.
PTFE Stopper with NS 7 Fitting	B0631128
PTFE Stopper with NS 6 Fitting, taper 1:10	B0631149

Material	Lightpath	Outside Depth	Cell Volume	Remarks	Part No.
NIR Quartz SUPRASIL 300	10 mm	12.5 mm	2.8 mL	Neck Ø 6 mm Taper 1:10	B0631099
NIR Quartz SUPRASIL 300	20 mm	22.5 mm	5.6 mL	Neck NS 7	B0631100
NIR Quartz SUPRASIL 300	50 mm	52.5 mm	14.0 mL	2 necks NS 7	B0631101
NIR Quartz SUPRASIL 300	100 mm	102.5 mm	28.0 mL	2 necks NS 7	B0631102
Quartz SUPRASIL	10 mm	12.5 mm	2.8 mL	Neck Ø 6 mm Taper 1:10	B0631095
Quartz SUPRASIL	20 mm	22.5 mm	5.6 mL	Neck NS 7	B0631096
Quartz SUPRASIL	50 mm	52.5 mm	14.0 mL	2 necks NS 7	B0631097
Quartz SUPRASIL	100 mm	102.5 mm	28.0 mL	2 necks NS 7	B0631098
Special Optical Glass	10 mm	12.5 mm	2.8 mL	Neck Ø 6 mm Taper 1:10	B0631091
Special Optical Glass	20 mm	22.5 mm	5.6 mL	Neck NS 7	B0631092
Special Optical Glass	50 mm	52.5 mm	14.0 mL	2 necks NS 7	B0631093
Special Optical Glass	100 mm	102.5 mm	28.0 mL	2 necks NS 7	B0631094

Disposable Cells

Disposable cells greatly reduce the risk of contamination, remove the need for cleaning reagents and lower laboratory costs compared to maintaining quartz or glass cells. Macro or semi-micro disposable cells are available in polystyrene (spectral range 340–900 nm), and polymethyl methacrylate (spectral range 300–900 nm). Disposable cells are also available in a special UV transparent material in macro, semi-micro and micro cells, with a useful spectral range of 220–900 nm.

Each cell has a standard lightpath of 10 mm and is suitable for any UV/Vis Spectrophotometer which accommodates cells with a center height of 15 mm. Color coded caps can be ordered for the micro UV transparent cells which allow samples to be stored down to -20°C.



Macro Cells

Description	Outside Dimensions	Cell Volume	Qty.	Part No.
UV Material	45 x 12.5 x 12.5 mm	2.5–4.5 mL	100	L7110269
Polystyrene	45 x 12.5 x 12.5 mm	2.5–4.5 mL	1,000	L7110271
Polymethyl Methacrylate	45 x 12.5 x 12.5 mm	2.5–4.5 mL	1,000	L7110273



Semi-micro Cells

Description	Outside Dimensions	Cell Volume	Qty.	Part No.
UV Material	45 x 12.5 x 12.5 mm	1.5–3.0 mL	100	L7110268
Polystyrene	45 x 12.5 x 12.5 mm	1.5–3.0 mL	1,000	L7110272
Polymethyl Methacrylate	45 x 12.5 x 12.5 mm	1.5–3.0 mL	1,000	L7110274



Micro Cells

Micro cells and caps are sold separately. These round caps allow for a tight closure and allow samples to be stored down to -20°C.

Description	Outside Dimensions	Cell Volume	Qty.	Part No.
UV Material	45 x 12.5 x 12.5 mm	70–550 µL	100	L7110260
UV Material	45 x 12.5 x 12.5 mm	70–550 µL	500	L7110261
UV Material Individually Wrapped	45 x 12.5 x 12.5 mm	70–550 µL	100	L7110262*
Caps – Blue			100	L7110264
Caps – Green			100	L7110266
Caps – Orange			100	L7110267

* Free of DNase, DNA and RNase.

Cell Rack

Also available is a cell rack for easy storage of samples. It is suitable for standard 10 mm light path cells and holds up to 16 cells in numbered positions to aid sample tracking. The cell rack can withstand temperatures up to 121°C so it can be used in an Autoclave.



N4103000

Description	Qty.	Part No.
Cell Rack, 16-Cell Capacity	1	L7110275

Cell Spacers

Cell spacers can be used to vary the cell pathlength.

Spacer	Dimensions	Description	Part No.
1 mm	38 x 12.5 x 9 mm	Fits cells with 1 mm optical path length into 10 mm cell holder	N9302741
1 mm	38 x 12.5 x 9 mm	A pair of 1 mm cell spacers	B0079413
2 mm	38 x 12.5 x 8 mm	Fits cells with 2 mm optical path length into 10 mm cell holder	N9302742
5 mm	38 x 12.5 x 5 mm	Fits cells with 5 mm optical path length into 10 mm cell holder	N9302743

* Free of DNase, DNA and RNase.

Cell Holders

To extend the range of samples that you can analyze, we offer a wide range of sample holders.

The rectangular and cylindrical long-path cell holders are ideal for sensitive measurements on dilute samples where the extra pathlength is important. For the chemist, the test tube holder provides a convenient method of sampling in-situ, no need to decant samples into standard cells. Finally, extend your measurement capabilities to include solid materials with the solid and variable-angle sample holders.

Standard Cell Holders

All PerkinElmer spectrometers come standard with at least one Cell Holder that fits the instrument. These holders accommodate a standard 10 mm rectangular cell. The High Performance instruments, LAMBDA 650/750/850/850+ /900/950/1050/1050+, also include a lifter, to allow for easier short cell removal and to assist with vertical and horizontal adjustments.



LAMBDA Model	Part No.
265	N4103000
365	N4101027
465	N4104000
20/30/40/20Bio/30Bio/40Bio/40P/25/35/45/650/750/850/850+/900/950/1050/1050+	B0505071

Variable Pathlength Cell Holders

This accessory is a single cell holder supporting rectangular cells of varying length.



LAMBDA Model	Pathlength (mm)	Part No.
265	5, 10, 20,40, 50	N4103002
365	5, 10, 20,40, 50, 100	N4101005*
465	5, 10, 20,40, 50, 100	N4104003*
650/750/850/850/900/950/1050/1050+/20/30/40/20Bio/30Bio/40Bio/40P	5, 10, 20,40, 50, 100	B0080821**

* Includes a partition plate to support cells through analysis.
 ** If desired, order a second cell holder to accommodate the instrument's second beam.

Long Path Cell Holders

These single cell holders accommodate cylindrical and rectangular cells of pathlengths from 10–100 mm long. These cell holders work with LAMBDA spectrometers 10/20/40/10Bio/20Bio/40Bio/40P/25/35/45/650/750/850/850/900/950/1050/1050+.



Description	Part No.
Rectangular	B0080821
Cylindrical	B0082539

Test Tube Holders

The LAMBDA 365 test tube holder accommodates test tubes, vials, ampules, and cylinder type cuvettes with a maximum sample size of 130 mm high. Both test tube holders can accommodate test tubes with diameters from 11–16 mm.



LAMBDA Model	Part No.
365	N4101018
20/30/40/20Bio/30Bio/40Bio/40P/25/35/45/650/750/850/850+/900/950/1050/1050+	B0500952

Solid Sample Holder – Single Cell

This single cell Solid Sample holder can accommodate a maximum sample size of 10 x 15 mm with a maximum thickness of 5 mm.



B0080822

LAMBDA Model	Part No.
20/30/40/20Bio/30Bio/40Bio/40P/25/35/45/650/750/850/850+/900/950/1050/1050+	B0080822

Micro Cell Holder

The Micro Cell Holder is designed for accurate positioning of small volume cells and accommodates any standard 10 mm cell and Nano sticks.



N4101028

LAMBDA Model	Part No.
365	N4101028

Variable Angle Sample Holder

These holders support a variety of positions for solid samples to aid transmission measurements.



N4101002



N4104006

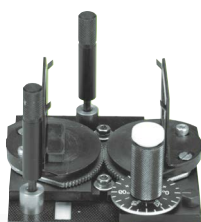

B0152471

LAMBDA Model	Angle (°)	Samples	LAMBDA 465 Part No.
365	0–75	Film, Glass, Plate*	N4101002
465	0–360	Film, Glass, Plate*	N4104006
20/30/40/20Bio/30Bio/40Bio/40P/25/35/45/650/750/850/850+/900/950/1050/1050+	0–60	Film, Glass, Transparent samples. Minimum sample size 30 x 40 mm	B0152471

* Accommodates samples of various sizes and thicknesses.

Advanced Transmission Holders

These holders are useful for transmission measurements on solid samples (films, filters, glass, plastics, etc.). The springloaded clamps securely hold objects of varying thicknesses.

N4103004



N4101001



N4101019



N4104005



N4104007

LAMBDA Model	Description	Part No.
265	Spring clamp holds samples up to 2.5 mm thick	N4103004
365	Adjustable arms hold samples of various thickness	N4101001
365	Specializes in transmittance measurements of thin samples, such as film	N4101019
465	Holds samples up to 7 mm thick	N4104005
465	Accommodates standard 10 mm cells, optionally mounts film samples with rubberized magnetic plates	N4104007

Reflectance Holders

Designed for measuring specular reflectance spectra. It is used for film thickness measurements.



N4103003



N4101003



N4104004

LAMBDA Model	Angle of Incidence	Part No.
265	30° (fixed)	N4103003
365	6°	B0086703*
365	30° (fixed)	N4101003
365	Variable angle	B0137314**
465	34° (fixed)	N4104004

* Requires Base Plate (N4101030) for installation.

** Requires Base Plate (N4101025) for installation.

Cell Changers

Automatic Linear Transport

The Automatic Linear Transport unit changes standard and reference cells for LAMBDA 20/40/20Bio/40Bio/40P/25/35/45 spectrometers. This product comes with the following cell changer kits: 5+5 (**N1010569**), 8+1 (**N1010567**), and 8+8 (**N1010568**). Compatible with the Water-Thermostatted 8-Cell Holder (**B2205411**), the Long Pathlength 5-Cell Holder (**B0089439**), and the Water-Thermostatted Reference Cell Holder (**B2000201**). For reference positions, the Reference Kit (**B2000310**) is required, but not included, when using the 5- and 8-cell holders.



8+1 Cell Changer Configuration

Description	Part No.
Automatic Linear Transport	B2000186

Cell Changers Kits

These Cell Changer Kits come standard with the Automatic Linear Transport (**B2000186**). No accessory PCB is required.

Description	Part No.
5+5 Long Pathlength, up to 50 mm Kit includes: Automatic Linear Transport (B2000186) Reference Kit (B2000310) Two Long Pathlength 5-Cell Holders (B0089439)	N1010569
8+1 Automatic, Water-Thermostatable Kit includes: Automatic Linear Transport (B2000186) 8-Cell Water-Thermostatted Cell Holder (B2205411) Single Cell Reference Holder (B2000201)	N1010567
8+8 Cell Changer Kit includes: Automatic Linear Transport (B2000186) Reference Kit (B2000310) 8-Cell Water-Thermostatted Cell Holder (B2205411)	N1010568

Reference Holders and Reference Kits

The Reference Holders and Kits are used with the Automatic Linear Transport unit (**B2000186**).

Description	Compatible with	Part No.
Single Cell Reference Holder, holds one cell, max 10 mm pathlength	N1010567	B2000201
Reference Kit, provides an add-on reference cell position	N1010569 N1010568	B2000310*

* The Reference Kit can serve as a reference position for 5-Position Long-Pathlength Cell Holder (**B0089439**) and 8-Cell Water-Thermostatted Cell Holder (**B2205411**).

Cell Changers for the LAMBDA 25/35/45

Manual Cell Changer

The Manual Cell Changer is compatible with LAMBDA 25/35/45 spectrometers. This base unit comes with an accessory cover. It requires, but does not include, the 5-Position Long Pathlength Cell Holder or the 8-Position Water-Thermostatted Cell Holder.

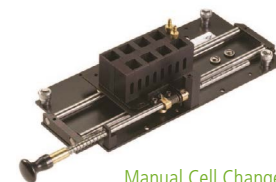

Manual Cell Changer
B2500080

Description	Part No.
Manual Cell Changer	B2500080
Accessory Cover	B0094014
5-Position Long-Pathlength Cell Holder	B0089439
8-Position Cell Holder, Water-Thermostatted	B2500081

13-Cell Changer System

System includes cell changer and one carousel (**B0185163**) for glass/quartz and plastic cuvettes. Magnetic stirrer fleas also included. Accessory PCB (**L6000500**) required for LAMBDA 25/35/45.

Description	Part No.
13-Cell Changer System for LAMBDA 25/35/45	B0185210

Cell Changer for the LAMBDA 265

8-Position Multi-Cell Changer

The 8-Position Multi-Cell Changer for the LAMBDA 265 holds 10 mm cells. It is not temperature-controlled.



8-Position Multi-Cell Holder
N4103007

Description	Part No.
8-Position Multi-Cell Holder, 10 mm	N4103007

Cell Changers for the LAMBDA 365

5+1 Position Variable Pathlength Cell Changer

Our 5+1 Position Variable Pathlength Cell Changer accommodates up to 5 sample cells with a pathlength up to 50 mm long. No temperature control capability.



5+1 Position Variable Pathlength Cell Holder **N4100104**

Description	Part No.
5+1 Position Variable Pathlength Cell Holder	N4100104

8-Position Multi-Cell Changer

The 8-Position Multi-Cell Changer accommodates 8 standard 10 mm cells. No temperature control capability.

Description	Part No.
8-Position Multi-Cell Holder	N4101006

8-Cell Changers with Manifold for Dissolution

Our 8-Cell Changer has been modified with a front manifold to easily accommodate flow cells with tubing to allow for easy dissolution testing. Inside tubing (**B2000049**) connects the flow-cells to the manifold and is sold separately. 18 tubes needed.



Water-Jacketed 8-Cell Changer for Dissolution **N4104019**

Outside tubing (**B2000515**) connects the manifold to the pump and is sold separately. 18 tubes needed.

Description	Part No.
8-Cell Changer with Manifold for Dissolution	N4104018
8-Cell Changer with Manifold and Water-Jacket for Dissolution	N4104019

Cell Changer for the LAMBDA 465

16-Position Multi-Cell Changer

The 16-Position Multi-Cell Changer accommodates 16 standard 10 mm cells.

No temperature control capability, but it can be used in dissolution. Requires, but does not include, IDIS dissolution software.



16-Position Multi-Cell Holder **N4104020**

Description	Part No.
16-Position Multi-Cell Holder	N4104020

Cell Changers for High Performance Spectrometers

HP LAMBDA Linear Cell Changer

The HP LAMBDA Linear Cell Changer transports sample or reference positions for the high performance LAMBDA spectrometers. Cell holders are required, but not included. Choose 2 x **B0089439** Long Pathlength 5-Cell Holder or 2 x **B2205411** 8-Cell Holder, water thermostatable.

LAMBDA Model	Part No.
650/750/850/850+/950/1050/1050+	L6020360

Thermostatting Accessories



9 Cell with Reference Cell **B20000159**

Our thermostatting accessories, highly accurate temperature control using either recirculated water or air, include water-jacketed cell holders, Peltier™ controllers, Peltier-controlled cell holders, stirrers, and probes.

Peltier Fluid Circulator (PCB-1500W)

The Peltier-Controlled Fluid Circulator is an external fluid circulator that can be used with all water-jacketed cell holders to effect both heating and cooling temperature control of cell holder positions. It has a temperature range of 20-60°C, with an accuracy of +/-0.15°C, and is enabled for PC programming.

Description	Part No.
Peltier-Controlled Fluid Circulator, 120 V	N1015158

Water Circulator, MB-5A

The Water Bath Circulator has a Plexiglass bath tank used for internal and external temperature control. Primarily used to control the temperature inside the tank, it can be used to control external closed systems via attachable pump connectors. This unit has a temperature range of 20-60°C, with an accuracy of +/-0.2°C, a precision thermometer, built in cooling coils, and a keypad for setpoints, warning/safety values and menu functions.

Description	Part No.
Water Circulator MB-5A, 220 V	B0080171

Temperature Measurement Kit

The Temperature Measurement Kit supplies an "in-cell" temperature measuring probe for the LAMBDA 20/30/40/20Bio/30Bio/40Bio/40P/25/35/45/650/750/850/850+/900/950/1050/1050+. It includes a glass cell. Accessory boards are required.



Temperature Measurement Kit

Description	Part No.
Temperature Measurement Kit	B0185227
LAMBDA 25/35/45 Accessory Board	L6000500
LAMBDA 650/750/800/850/850+/900/1050/1050+ Accessory Board	B2205116

Water-Jacketed Cell Holders

These water-jacketed holders maintain temperature control for standard 10 mm cells using recirculating liquid. These holders do not include the required recirculating bath (**B0080171**) or (**N1015158**). Locally-sourced baths also work.



Water-Jacketed Single Cell Holder **N4101007**



Water-Jacketed Single Cell Holder **N4103001**



Water-Jacketed 8-Position Multi-Cell Holder **N4103006**



Water-Jacketed Automatic Referencing Stage **N4104013**

LAMBDA Model	Description	Part No.
265	Single	N4103001
365	Single	N4101007
465	Single	N4104002
465	2-Position Referencing Stage. Provides long-term stability for monitoring kinetics reactions. Holds a sample and a reference sample	N4104013
2/12/14/14P/10/10 Bio/20/20 Bio/40/40 Bio/40P/265/465/650/750/ 800/850/850+/900/950/1050/1050+	Single	B0080819*
850/850+/1050/1050+	8-Position	B2205411**

* This water-jacketed single cell holder provides sample temperature control for all PerkinElmer UV/Vis spectrometers, except the LAMBDA 365.

** The Water-Jacketed 8-Position Multi-Cell Holder (**B2205411**) requires the Linear Cell Changer (**B2000186**) when working with the LAMBDA 25/35/45. It requires the Cell Programmer (**L6020360**) when working with the LAMBDA 650/750/850/850+/900/950/1050/1050+.

Water-Jacketed Cell Changers

These water-jacketed cell changers hold standard 10 mm cells, and require, but do not include, a recirculating bath for sample temperature control. PerkinElmer offers two baths **B0080171** and **N1915158**. Locally-sourced baths are also acceptable. Tubing connectors differ with each LAMBDA model.



Automatic Water-Jacketed 8-Position Multi-Cell Holder **N4104001**



Water-Jacketed 8-Position Multi-Cell Holder **N4101006**

LAMBDA Model	Description	Part No.
265	8-Position	N4103006
365	8-Position	N4101014*
465	8-Position	N4104001
2/12/14/14P/10/10 Bio/20/ 20 Bio/40/40 Bio/40P/265/365/465/650/750/ 800/850/850+/900/950/ 1050/1050+	8-Position	B2205411*

* For the LAMBDA 365, this changer requires, but does not include, the Front Plate Tube Connection Kit (**N4101026**).

Peltier Temperature Control Systems

The Peltier Temperature Control Systems work with LAMBDA spectrometers, allowing you to easily control the heating and cooling rates of samples through a combination of temperature controllers, cell holders, cell changers, stirrers, and probes. The systems are ideal for lubricant, paint, cosmetics, food, as well as hot and polymer melt analysis. They provide highly accurate temperature control using either a fluid circulator or air.

PTP-A Single-Cell Peltier Controller

The PTP-A Single-Cell Peltier unit is air-cooled and does not require a source of cooling water, making it very convenient to use with minimal setup time. Temperature programs are set up, edited and stored from the front panel of the controller unit. The PTP-A is ideal for protein and nucleic assays to 37°C and for studies of kinetics, thermodynamics and acid-base equilibria.



PTP-A Single-Cell Peltier Controller
L6310014

Description	Part No.
PTP-A Single-Cell Peltier Accessory	L6310014*

* For use with LAMBDA 20/30/40/20Bio/30Bio/40Bio /40P/25/35/45/650/750/850/ 850+/900/950/1050/1050+. PKI offers optional Adapter Plates (**N4100125** or **N4101030**) to use the controller with LAMBDA 365 spectrometers.

Peltier Controllers

Peltier Controllers come with an internal liquid cooling system, N₂ purge gas capability, a magnetic stirrer control, emergency power off switch and software control of temperature and stirring.



Peltier Temperature Controller
N4100040

Features include:

- Temperature Range: -5–100°C.
- Temperature Accuracy: ± 0.1°C.
- Temperature Precision: 0.1°C.

Controllers can be ordered with or without a Peltier-controlled single/multi cell holder. The units work with Peltier controlled accessories such as cell holders, stirrers, and probes. All Peltier instruments ship with 2 probes, however, both probes are only needed for the LAMBDA 365 Single Cell Peltier with Reference Heat and the LAMBDA 365/465 Multi-Cell Peltier.

LAMBDA Model	Part No.
265/365/465 coolant included	N4100040

Peltier-Controlled Thermostatting Accessories

Single Cell Holder Accessories

Single cell holder accessories are for the sample or reference positions, or both. Also included are a power supply, power cables, and User's Guide. Selectable temperature range 20–45°C.

Requires the LAMBDA 25, 35, 45 Accessory Board (**L6000500**).

LAMBDA Model	Description	Part No.
25/35/45	Single Sample Holder Accessory	B2000159*
25/35/45	Optional Single Reference Holder	B0510412
25/35/45	Single Sample Holder + Sample Reference Holder Accessory	N1010565*

* Includes a reference position cover.

9-Position Sample Accessory

Includes the Peltier 9-Position cell changer, an additional interchangeable 9-Position cell holder (**B0510366**) to use with the 9-Position cell changer. 5 beam masks, alignment gauge, reference position cover, sample compartment extension, power supply, power cables, and User's Guide. Must be service installed. Selectable temperature range 20–45°C.

Requires the LAMBDA 25, 35, 45 Accessory Board (**L6000500**).

LAMBDA Model	Part No.
25/35/45	B2000160

9-Position Sample Accessory + Single Reference Accessory

Includes the Peltier 9-Position Sample Accessory (**B2000159**) for the sample position and the Single Reference Accessory (**B0510412**) for the reference position. Also included are 5 beam masks, alignment gauge, reference position cover, sample compartment extension, power supply, cables, and User's Guide. Selectable temperature range 20–45°C. Must be service installed.

Requires the LAMBDA 25, 35, 45 Accessory Board (**L6000500**).

LAMBDA Model	Part No.
25/35/45	N1010566

9-Position Cell Holder

As included with the Peltier 9-Position Sample Accessory. Additional interchangeable cell holder for use with the 9-Position cell changer.

LAMBDA Model	Part No.
25/35/45	B0510366

Stirring Rods

Set of 15 pieces for stirring in the cuvette. For use with the Research Peltier System 6-Position (PTP-6) (**L6310011**), and 13-Cell Changer Systems (**B0185210**), and Magnetic Stirrer Accessory (**N4101015** or **N4101016**).

Description	Part No.
Stirring Rods	B0187028

Peltier-Controlled Single Cell System

Useful for thermal denaturation, kinetics and other applications, it comes with full software control of temperature, stirring for 1 sample, and has a built-in radiator that maintains temperature of circulating coolant (reorder part number **HH33450003**). Includes a Peltier controller (**N4100040**) with single cell holder and 2 temperature probes.

Temp. Control Range: -5–100°C
 Temperature Accuracy: ± 0.1°C
 Temperature Control Precision: <0.1°C



Single Peltier Temperature Control Unit L265 **N4101053**

LAMBDA Model	Part No.
265	N4101053

Single Cell Peltier Systems

These holders contain a Peltier controller (**N4100040**) and a single cell holder.



N4101060



N4101061

Description	LAMBDA Model	Part No.
Single Cell Holder	365	N4101060*
1+1 Peltier Holder	365	N4101061**

* Temperature Control: Sample only. ** Temperature Control: Both Sample and Reference.

6-Position Peltier Controlled Cell Changer, Controller (without Heated Reference)

This product accommodates up to 6 samples for automated measurement. It has full software control of temperature and stirring, with a built-in radiator that maintains temperature of circulating coolant. It includes a Peltier controller (**N4100040**) with 6-Position Multi-Cell Holder and 2 temperature probes.

Temperature Control: Sample only.



6-Position Peltier Controlled Cell Changer **N4101063**

LAMBDA Model	Part No.
365	N4101063

6+1 Position Peltier Controlled Cell Changer, Controller (with Heated Reference)

This product accommodates up to 6 samples and has full software control of temperature and stirring. It contains a built-in radiator that maintains temperature of circulating coolant. It includes a Peltier controller (**N4100040**), a 6-Position Multi-Cell Holder (with heated reference) and 2 temperature probes.

Temperature Control: Both Sample and Reference.



6+1 Position Peltier Controlled Cell Changer **N4101062**

LAMBDA Model	Part No.
365	N4101062

Peltier Control Single Cell, with Peltier Controller (without Heated Reference)

This holder has full software control of temperature and stirring for 1 sample. Included is a Peltier controller (**N4100040**) with single cell holder and 2 temperature probes.

Temperature Control Range: -5–100°C
 Temperature Accuracy: ± 0.1°C
 Temperature Control Precision: 0.1°C



Peltier Control Single Cell, with Peltier Controller **N4101090**

LAMBDA Model	Part No.
465	N4101090

Peltier Control Multi-Cell (8), with Peltier Controller (with heated reference)

This holder accommodates up to 8 samples for automated measurement with full software control of temperature and stirring, and a built-in radiator that maintains temperature of circulating coolant. Included is a Peltier controller (N4100040), 8-Position multi-cell holder (with heated reference) and 2 temperature probes. Can be configured to 7 sample + 1 heated reference.



Peltier Control Multi-Cell (8), with Peltier Controller N4101091

Temperature Control Range: -5–100°C
 Temperature Accuracy: ± 0.1°C
 Temperature Control Precision: 0.12°C

LAMBDA Model	Part No.
465	N4101091

Research Peltier System, 1+1 Position (PTP 1+1)

The 1+1 Position (PTP 1+1) accessory provides temperature control for one rectangular cell each in the sample beam and the reference beam. It has a temperature range of 0–100°C. The Circulator is for stability. Water will freeze at 0°C. Stirring is included. Flexible programming of temperature ramps up to 8 segments is possible.

LAMBDA Model	Part No.
20/20Bio/40/40Bio/40P/25/35/45/ 650/800/850/850+/900/950/1050/1050+	L6310012

Research Peltier System, 6-Position (PTP-6)

The 6-Position (PTP-6) accessory provides temperature control for six rectangular cells in the sample beam. It has a temperature range of 0–100°C and includes stirring. The Circulator is for stability. Water will freeze at 0°C. Flexible programming of temperature ramps up to 8 segments is possible.



Research Peltier System, 6 Position (PTP-6) L6310011

LAMBDA Model	Part No.
20/20Bio/40/40Bio/40P/25/35/45/ 650/800/850/850+/900/950/1050/1050+	L6310011

Research Peltier Accessories

The research Peltier accessories consist of Peltier-controlled, single or six-cell holders for the sample and reference channels. Single-channel versions are also available. The accessories include cell stirring and the ability to preset temperature programs. These units require a source of cooling water with a temperature range of 0–100°C. Flexible programming up to 8 segments of the cell sample temperature is possible. These accessories require, but do not include, a water circulator (N1015158 or B0080171).

Research Peltier System, Single Cell (PTP-1)

The Single Cell (PTP-1) provides temperature control for one rectangular cell in the sample beam. It has a temperature range of 0–100°C. Flexible programming of temperature ramps up to 8 segments is possible. The Circulator is for stability. Water will freeze at 0°C. For thermostating the reference cell holder, use the non-Peltier Water-Jacketed Holder, such as B0080819, with an appropriate temperature Circulator (not included).



Research Peltier System, Single Cell (PTP-1) L6310010

Research Peltier Systems 6+6 Position (PTP 6+6)

The 6-Position (PTP-6) accessory provides temperature control for six rectangular cells in the sample beam and six rectangular cells in the reference beam. It has a temperature range of 0–100°C and includes stirring. The Circulator is for stability. Water will freeze at 0°C. Flexible programming of temperature ramps up to 8 segments is possible.

LAMBDA Model	Part No.
20/20Bio/40/40Bio/40P/25/35/45/ 650/800/850/850+/900/950/1050/1050+	L6310013

LAMBDA Model	Part No.
20/20Bio/40/40Bio/40P/25/35/45/ 650/800/850/850+/900/950/1050/1050+	L6310010

Specular Reflectance Accessories

The Fully-Automated Universal Reflectance Accessory (URA)

PerkinElmer's unique Universal Reflectance Accessory (URA) is the only fully-automated, multi-angle, absolute specular reflectance accessory available today.

Simply place the sample on the horizontal sampling plate, select the required measurement angles and scan. Unlike traditional methods, the URA automatically and reproducibly changes the measurement angle, eliminating time-consuming manual mirror adjustments and changes of accessory. This approach reduces running costs and increases productivity. The URA snaps in the second sampling position and interchanges easily with other detector modules.



Features include:

- Measurement range: 190–3,100 nm (UV/Vis/NIR), 190–900 nm (UV/Vis)
- Angular range: 8° up to 65° incident angle
- Depolarization recommended for angles larger than 10°
- Measure separate S&P polarizations using the Polarizer/Depolarizer Drive (**B0505530**). See Polarizers and Depolarizers for more information
- Absolute and relative measurements can be made. Transmission mode also possible
- Typical applications include the measurement of anti-reflection coatings, high-reflectors, coating thickness and metallic reflectors

LAMBDA Model	Description	Part No.
650/850/850+	URA (UV/Vis)	L6020208
950	URA (UV/Vis/NIR)	L6020202
1050/1050+	URA (UV/Vis/NIR)	L6020358

Relative Specular Reflectance Accessories

The Fixed Angle Reflectance Accessory is ideal for reflectance or thickness measurements. It has a 6° fixed angle of light incidence.

Features and Benefits:

- Locates in the standard sample compartment for routine relative specular reflectance measurements at a 6° fixed angle of incidence
- Accommodates samples from 20 x 20 mm to 100 x 100 mm
- Wavelength range: 175–3,300 nm

LAMBDA Model	Part No.
25/35/45/365/650/750/800/850/850+/ 900/950/1050/1050+	B0086703*

* Can be used with the LAMBDA 365, but requires base plate (**N4101030**) for installation.

Variable-Angle Relative Specular Reflectance Accessory

For relative specular reflectance studies requiring data from multiple angles of incidence, the Variable-Angle Relative Specular Reflectance accessory is ideal. Typical applications include the study of the how the reflectivity of a sample changes with change of incident angle.

Features and Benefits:

- Wavelength range: 175–3,300 nm
- Locates in standard sample compartment
- Range of angles: 15–70°, with an accuracy of +/- 1°

LAMBDA Model	Part No.
25/35/45/365/650/750/850/850+/950/1050/1050+	B0137314*

* Can be used with LAMBDA 365, but requires the Base Plate for the Variable Angle Reflectance Holder (**N4101025**).

Spare Standard Mirror

PerkinElmer offers a spare (uncalibrated) reflectance mirror for the Relative Specular Reflectance Accessory, 6° (**B0086703**) and the Variable Angle Reflectance Accessory (**B0137314**).

Description	Part No.
Spare Standard Mirror, Uncalibrated	B0071519

Powder Sample Holder Set

The Powder Sample Holder Set includes the following powder-packing fixtures: a plunger, a press cylinder and cap, two 4.2 ml cups, and one 7.2 ml sample cup. Comes with instructions.

LAMBDA Model	Part No.
650/750/800/850/850+/900/950/1050/1050+	PELA9040

Diffuse Reflectance Accessories

Diffuse Reflectance Accessory

The Diffuse Reflectance Accessory is used for measuring the diffuse reflectance (SCE) and color analysis for solid and powder samples. It has a spectral range of 270–1000 nm (UV and Visible), and a selectable port size of 10 and 5 mm. Includes a Xenon Lamp (150W) and a White Standard. Input power is 100–240 V.



Diffuse Reflectance accessory
DRA-100 **N4104008**

LAMBDA Model	Part No.
465	N4104008

50 mm Transmission/Reflectance Sphere

The high sensitivity 50 mm Transmission/Reflectance Sphere is used for measuring diffuse reflectance (specular component included – SCI), total transmittance or hemispherical transmittance, and performing color analysis. It has a spectral range of 230–1100 nm (UV and visible). It has a port size of 10 mm and the recommended spectral bandwidth setting is 5 nm. Included is a White Standard.

Recommended for solid color analysis.



Integrating Sphere
N4101011

LAMBDA Model	Part No.
365	N4101011

Small Spot Kits for White Standard

Small Spot Kits are used inside the 150 mm Integrating Spheres (**L6020364** and **L6020365**).

LAMBDA Model	Description	Part No.
650/850/850+/ 950/1050/1050+	Small Spot Accessory Kit This kit reduces the beam size to the transmittance, center mount, and diffuse reflectance positions	L6020211

Powder Cell Holder Kit for 50 mm Sphere

The Powder Cell Holder Kit is used with the 50 mm Transmission/Reflectance sphere to measure the reflectance of paste and powder samples. The kit includes: A powder cell and cover, two Quartz windows (for dark current measurements), and two Quartz caps (baseline white standard reference).



Quartz guide for light
trapper (2 ea)



Powder cell (1 ea)



Quartz cap for White
Standard (2 ea)

Powder Sampling Accessory **N4101049**

LAMBDA Model	Part No.
365	N4101049

Praying Mantis Accessories

Diffuse reflection spectroscopy is a very sensitive method for detecting changes at the surfaces of rough materials. It is particularly effective for powders that have high surface areas. This makes the Praying Mantis an invaluable tool for analysis of heterogeneous catalysis, gas-solid interactions, photochemical reactions, and oxidation mechanisms.

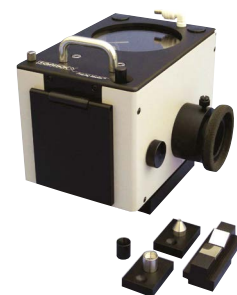

Features include:

- A very small (approx. 2 mm) spot size.
- Wavelength range: 200–3300 nm.
- Pivoting ellipsoids that provide easy access to the sampling area and ensure a highly efficient diffuse reflection illumination and collection system.

LAMBDA Model	Part No.
650/750/800/850/850+/ 900/950/1050/1050+	L6310211

Optional Praying Mantis Configurations

The Praying Mantis can be configured to study materials and reactions in controlled environments with the Low Temperature and the High Temperature Diffuse Reflection Reaction Chambers.

Both chambers include:

- Reaction chamber, made of chemically-resistant 316 stainless steel, with three inlet/outlet ports.
- Low-voltage heating cartridge.
- K-type thermocouple.
- Sample packing tool and spill tray.
- Dome with two SiO₂ windows as well as one glass observation window (UV/Vis/NIR configuration).

Praying Mantis Low Temperature Reaction Chamber UV/VIS

Used in conjunction with the Praying Mantis accessory (**L6310211**), the Low Temperature Reaction Chamber allows diffuse reflection measurements under a wide range of controlled temperatures and pressures.

- Designed for studies from high vacuum (133 μ Pa or 10–6 torr) – 133 kPa (1 ktorr) and at temperatures from -150–600°C (under vacuum).



L6310216

LAMBDA Model	Part No.
650/750/800/850/850+/900/950/1050/1050+	L6310216

Praying Mantis High Temperature Reaction Chamber UV/VIS

Used in conjunction with the Praying Mantis accessory (**L6310211**), the High Temperature Reaction Chamber is well suited for performing diffuse reflection (DRIFTS) spectroscopic measurements under controlled pressures and a wide range of temperatures.

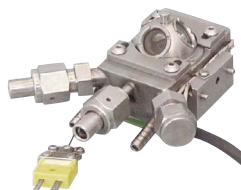

L6310215

Features include:

- Designed for operation from high vacuum, 133 μ Pa (10–6 ktorr) – 133 kPa (1 ktorr) with KBr windows or 1.5 MPa (11.3 ktorr) with ZnSe windows.
- Achieves temperatures up to 910°C (under vacuum).
- Readily adapted for operation up to 3.44MPa (25.8 ktorr) with an optional high-pressure dome.
- Optional Silcotek/Restek inert coatings available for greater inertness and corrosion resistance.
- Optional cooling cartridge available for moderate cooling or heating with a chiller or recirculator.

LAMBDA Model	Part No.
650/750/800/850/850+/900/950/1050/1050+	L6310215

Specialty Accessories

Automated Reflectance/Transmittance Analyzer (ARTA)

The Automated Reflectance/Transmittance Analyzer (ARTA) is a drop-in accessory for the LAMBDA™ 950, 1050 and 1050+ UV/Vis/NIR spectrometers that uses a goniometer to rotate a sample with respect to the beam (varying angle of incidence) and independently rotate an integrating-sphere detector with respect to the sample (varying angle of detection). For any incidence angle/detection angle pairing, spectra may be collected for s- and p-polarized light in the wavelength range of 250–2500 nm.

Description	Part No.
Automated Reflectance/Transmittance Analyzer (ARTA)	L6020116
Angular Scattering Option for the Automated Reflectance and Transmission Measurement System (ARTA)	L6020117
Sample Tilt Option for the Automated Reflectance and Transmission Measurement System (ARTA)	L6020118

Large Sample Reflectance Transmittance Accessory (LSRT)

The Large Sample Reflectance Transmittance Accessory (LSRT) performs reflectance and transmittance measurements on very large, toughened glass panes and bended glass, such as car windows. The reflectance and transmittance measurement is at a normal incidence, with a wavelength range of 250–2500 nm and a measurement spot size of approximately 7 x 13 mm.

Description	LAMBDA Model	Part No.
Large Sample Stage. Motorized, Reflectance Transmittance Accessory (LSRT)	950/1050/1050+	L6310248

Magnetic Stirrer Accessories

The Magnetic Stirrer Accessories consist of a magnetic stirring controller, a stirring head, and a magnetic stirring bar for 10 mm pathlength cuvettes. They have an operating temperature range of -10–50°C. Choose between a manual or automatic control.

Description	Cells Stirred	Part No.
Magnetic Stirrer Accessory, Manual, 10 W Ideal for stirring small to medium volumes of low-viscosity liquids. RPM range of 120–1200 rpm	1	N4101015
Magnetic Stirrer Accessory, Automatic, 20 W Two stirring channels, large easy-to-read graphic display with an extra wide speed range of 100–1600 rpm	2 (max)	N4101016
Magnetic Stirrer Accessory, Automatic, 20 W Two stirring channels, large easy-to-read graphic display with an extra wide speed range of 100–1600 rpm	4 (max)	N4101017

Rapid Mixing Accessories

These accessories monitor kinetics reactions in solution using a stopped-flow technique.

Features include:

- Dead Time: 8 ms.
- Optical Lightpath: 2 mm, 10 mm.
- Ratio mixing: up to 10:1 (using different-sized syringes).
- Min. Vol./Shot/ Reagent: 120 μ L.

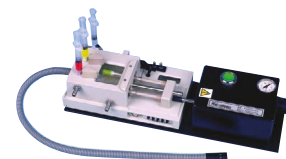
Rapid Mixing Accessory, Pneumatic Drive **N4104015**

Description	Part No.
Rapid Mixing Accessory	N4104014
Rapid Mixing Accessory, Pneumatic Drive	N4104015*

* Has push button operation and best accuracy for zero-time measurements.





150 mm Integrating Sphere

Integrating Spheres

PerkinElmer's range of snap-in integrating spheres is the industry standard for the measurement of total reflectance, diffuse reflectance and diffuse transmittance measurements for a huge range of sample types. The 150 mm Integrating Sphere is the recommended accessory for measurement of total solar reflectance and transmittance in the glass industry and for the measurement of UV transmittance of paint films in the automotive industry. Many national laboratories use it in R&D studies and for calibration measurements.

The 60 mm and 100 mm Integrating Sphere are used for routine diffuse reflectance and diffuse transmittance measurements. All Spheres are a snap-in module which fits into the second sample compartment position. This leaves the primary sample compartment free for the use of accessories or the polarizer/depolarizer drive.

Features and Benefits:

- Measurement range: 250–2,500 nm (UV/Vis/NIR), 250–900 (UV/Vis)
- Where fitted, InGaAs versions offer higher sensitivity in the near-IR range
- Sampling modes include total and diffuse reflectance at an incident angle of 8°, and total and diffuse transmittance at normal (0°) incidence

Integrating Spheres – PMT/PbS Modules

Comprising Integrating sphere PbS module includes a 60 mm, 100 mm, or 150 mm high performance PbS detector that is ready to be used without any adjustment. The sphere is located in a module that easily snaps into the spectrometer, allowing the standard sample compartment to remain free.

Features of the 60 mm PbS Module:

- Includes a 60 mm diameter high performance sphere.
- 0° / 8° for sample and reference reflectance ports (0° measures without gloss).
- Port Fraction ratio of 11.3%.
- Includes two non-calibrated 1.25" white standards.
- Wavelength range:
Reflectance 250–2500 nm.
Transmittance 250–2500 nm.

Features of the 100 mm PbS Module:

- Includes a 100 mm diameter high performance sphere.
- Port fraction ratio of less than 4% for high sensitivity.
- Includes port baffles for increased accuracy measurements of diffuse samples.
- 0° / 8° reflectance port (0° measures without gloss).
- Includes a cell holder for 100 mm cuvettes (**L6022022**) and one non-calibrated 2" white standard (**L6020319**).
- 0° transmittance port can be opened from 13–32 mm width.
- Wavelength range: 250–2500 nm.

Features of the 150 mm PbS Module:

- Includes a 150 mm diameter high performance sphere.
- Port baffles for high accuracy measurements of diffuse samples.
- Port Fraction ratio of 2.5%.
- 8° for sample and reference reflectance ports. Measurement with and without gloss possible.
- Includes two non-calibrated 2" white standards.
- 0° transmittance port. Haze measurement possible.
- Optional cell holder.
- Wavelength range:
Reflectance 250–2500 nm.
Transmittance 250–2500 nm.

Integrating Sphere	LAMBDA Model	Part No.
60 mm PbS Module	650/750/850/850+/ 950/1050/1050+	L6020203
100 mm PbS Module	650/750/850/850+/ 950/1050/1050+	L6020372
150 mm PbS Module	650/850/850+/ 950/1050/1050+	L6020365*

* Not suitable for LAMBDA 750.

Integrating Spheres – PMT/InGaAs Modules

Comprising Integrating sphere InGaAs module includes a 100 mm or 150 mm high performance InGaAs detector that is ready to be used without any adjustment. The sphere is located in a module that easily snaps into the spectrometer, allowing the standard sample compartment to remain free.

Features of the 100 mm InGaAs Module:

- 100 mm diameter high performance sphere.
- Port fraction ratio of less than 4% for high sensitivity.
- Includes port baffles for increased accuracy measurements of diffuse samples.
- 0° / 8° for reflectance port (0° measures without gloss).
- Includes a cell holder for 100 mm cuvettes and one non-calibrated 2" white standard (**L6020319**).
- 0° transmittance port can be opened from 13–32 mm width.
- Wavelength range:
Reflectance 250–2500 nm.
Transmittance 250–2500 nm.

Features of the 150 mm InGaAs Module:

- 150 mm diameter High Performance Sphere.
- Includes port baffles for high accuracy measurements of diffuse samples.
- Port Fraction ratio of 2.5%.
- 8° for sample and reference reflectance ports. Measurement with and without gloss possible.
- Includes two non-calibrated 2" white standards.
- 0° transmittance port. Haze measurement possible.
- Optional cell holder.
- Wavelength range:
Reflectance 250–2500 nm.
Transmittance 250–2500 nm.

Integrating Sphere	LAMBDA Model	Part No.
100 mm InGaAs Module	650/750/850/850+/ 950/1050/1050+	L6020371
150 mm InGaAs Module	650/850/850+/ 950/1050/1050+	L6020364*

* Not suitable for LAMBDA 750.

Upward Looking 270 mm Integrating Sphere

The Upward Looking 270 mm Integrating Sphere is a unique accessory enabling new accuracies to be achieved in the measurement of light-diffusing materials.

Features include:

- UV/Vis detector is a photomultiplier tube (PMT); NIR detector has broadband InGaAs with triple stage Peltier cooling.
- Angle of incidence 8° in both transmission and reflection.
- Measurement accuracy < 0.2T%, < 0.5R% for specular samples.
- Closed compartment sample size:
250 mm x 400 mm (minimum).
- Supports horizontal orientation of samples.
- Supports NFRC standards.
- Wavelength range 300–2,450 nm.

Integrating Sphere	LAMBDA Model	Part No.
Upward Looking 270 mm	950/1050/1050+	L6310220

100 mm Integrating Spheres Accessories

Description	LAMBDA Model	Part No.
Cell Holder, 1 mm cuvette	650/750/850/850+/ 950/1050/1050+	L6022022
Powder Sample	650/750/850/850+/ 950/1050/1050+	L6022025
Transmission Port Small Spot Kit. Includes apertures for 10, 5 and 3 mm beam sizes	650/750/850/850+/ 950/1050/1050+	L6022023*
Reflectance Port Small Spot Kit. Includes apertures for 10, 5 and 3 mm beam sizes	650/750/850/850+/ 950/1050/1050+	L6022024**

* Requires Reflectance Aperture Kit (**L6020314**). ** Requires Sample Compartment Iris (**L6020316**).

150 mm Integrating Spheres Accessories

The Clip-style sample holders are best for films and paper samples. The Jaw-style sample holders are ideal for glasses, prisms, and other solid samples. Both holders hang inside the integrating spheres.



Clip-style sample holder
PELA9039

Description	LAMBDA Model	Part No.
Clip Style (films and papers)	650/850/850+/ 950/1050/1050+	PELA9039
Jaw Style (glasses, prisms, and other solid samples)	650/850/850+/ 950/1050/1050+	PELA9038
Cuvette, 1 cm (transmission/reflectance mode measurements)	650/850/850+/ 950/1050/1050+	C6951019

Polarizers and Depolarizers

Double Polarizer Drive

When samples are oriented and polarize incident light, it is important to correct for the polarizing effect of the spectrometer's optics by using a depolarizer. Another important application is to make measurements using a specific orientation of incident radiation e.g., for crystalline materials and polymers.



Features and Benefits:

- Measurement range (Depolarization): 185–2,600 nm
- Measurement range (with Polarizers): 400–700 nm (Film), 300–2,600 nm (Glan-Thompson), 210–1,000 nm (Glan-Taylor)
- Fits into standard sample compartment alongside reflectance accessories and transmittance sample holders
- Suitable for reflectance and transmittance measurements

The high performance Double Polarizer/Depolarizer Drive is installed in the primary sample compartment. The polarization/depolarization orientation can be fully automated, changed by a scan at a fixed wavelength or with a stepping mode. Resolution of 0.25° for scanning. The polarization (depolarization) orientation in the stepping mode can be changed at up to 20 wavelength positions. Applications include specular reflectance studies of optics, coatings, metallic reflectors and thin films. The Double Polarizer Drive can operate with the Universal Reflectance Accessory (**L6020208**, for the LAMBDA 850/850+; **L6020202**, for the LAMBDA 950; or **L6020358**, for the LAMBDA 1050/1050+) or with manual specular reflectance and transmission accessories.

Description	LAMBDA Model	Part No.
Double Polarizer Drive	650/750/850/850+/ 950/1050/1050+	B0505530

Polarizer/Depolarizer Elements for the Double Polarizer Drive

The Double Polarizer Drive requires, but does not include, one or two of the polarization elements listed below. A range of polarizing materials is available, according to the required wavelength range. To ensure equal energy in the spectrometer's sample and reference beams, two are required.



Description	Wavelength Range	Part No.
Film Polarizer	400–700 nm	B2205022
Glan-Thompson Polarizer Crystal	300–2,600 nm	B0505284
Glan-Taylor Polarizer Crystal	210–1,000 nm	N1010520
Depolarizer Crystal (98% efficiency)	190–2,600 nm	B2205021

Common-Beam Depolarizer

Another approach to depolarization involves the use of a software-controlled depolarizer inside the spectrometer. Driven by a stepper drive and controlled by UV WinLab™ software, the Common-beam Depolarizer operates between 190 and 2,600 nm, and uses a double-wedge quartz/SUPRASIL design for 92% depolarization efficiency. Service installation is required.



Description	LAMBDA Model	Part No.
Common Beam Depolarizer	650/750/850/850+/ 950/1050/1050+	B0501282

General Purpose Optical Bench

General Purpose Optical Bench (GPOB)

The General Purpose Optical Bench (GPOB) accessory enables custom optical measurement configurations using a magnetized, ruled optical bench with a movable 60 mm integrating sphere. Samples up to 400 mm in pathlength can be analyzed. The GPOB wavelength range is 190–2500 nm.

Description	LAMBDA Model	Part No.
PbS General Purpose Optical Bench	650/850/850+/950/ 1050/1050+	PELA1003
InGaAs General Purpose Optical Bench	650/850/850+/950/ 1050/1050+	L6020328

GPOB Accessories

The products in these kits come mounted on magnetized bases.

Description	Part No.
Sample Holders Mount Kit Includes two cantilever sample holders with bases	PELA1005
Variable Angle Transmittance Sample Holder Kit This holder positions samples on an angle to the incident beam for transmittance measurements. Maximum sample size: 1 cm thick and 10 cm square	PELA1006
Fiber Optic Measurement Stage and Holder This kit consists of two fiber optic holders, allowing for measurement of small diameter fibers and fixed apertures	PELA1015
Optical Bench Kit This kit provides two iris diaphragms on two optical rails	PELA1008
Lens Assembly Kit This kit allows you to focus the beam on a small spot using of several plane convex lenses and iris diaphragms	PELA1007
Beam Blocker Kit This kit includes an optically black beam blocker	PELA1014
Light Trap Aperture Kit This kit contains black glass light traps and iris diaphragms	PELA1010
Short Focal Length Mirror Kit This kit consists of a short focal length (20–30 mm) concave mirror on an adjustable base, to accommodate spot incidence of curved samples	PELA1013
Flat Mirror Kit This kit consists of two 2 in. square plane mirrors	PELA1012
Specular Reflectance Kit This kit consists of six mirrors, two square flat mirrors with magnesium fluoride overcoat, two concave, and two convex mirrors	PELA1011

Fiber Optic Probes and Accessories

Fiber Optic Probe Coupling Modules are compatible with the LAMBDA 365/465 spectrometers. They consist of the fiber optic probe and either a 10 mm, 5 mm, or 2 mm pathlength tip. Tips are made of LS-HOH (Low Solarization HOH) fiber and a UV-enhanced aluminum-coated mirror. Easy to clean.



Fiber Optic Probe
N4101048

Features include:

- Wave length Range 200–1100 nm.
- Fiber Optic Prob Size: 600 µm.
- Probe Diameter: Ø 0.125".
- Fiber Optic Probe Length: 93 cm.
- Temperature Limit: 100°C.

Description	Part No.
Fiber Optic Probe with 10 mm Tip	N4101048
5 mm Tip	N4101506*
2 mm Tip	N4101505*

* Supplemental tip for **N4101048**.

Fiber Coupling Module

When combined with Fiber Optic Probe (**N4101048**), the Fiber Coupling Module can be used for measuring liquid samples; intended for hazardous samples.

Dimensions (WxHxD):
132 x 131 x 240 mm.



Fiber Coupling Module
for LAMBDA 465
N4104012

Fiber Coupling Module
for Lambda 365 **N4101013**

Description	LAMBDA Model	Part No.
Fiber Optical Module	365	N4101013*
Fiber Optical Module, Probe included	465	N4104012

* Required, but not included, Fiber Optic Probe **N4101048**.

Fiber Optic Dip Probe Kit

The Fiber Optic Dip Probe Kit includes a 1.5 m, 316 grade stainless steel probe with a wavelength of 200-1100 nm.

Requires but does not include:

- Transfer Optic Accessory (**B0509546/L6020290**).
- Light Shield (**N1016074**).
- Choice of probe tip (2 mm, **N1016073**; 5 mm, **N1016072**; or 10 mm, **N1016071**).

LAMBDA Model	Part No.
20/20Bio/40/40Bio/25/35/45 650/750/850/850+/950/1050/1050+	N1016070
Light Shield	N1016074
Tip, 10 mm	N1016071
Tip, 5 mm	N1016072
Tip, 2 mm	N1016073

Transfer-Optic Accessory

The Transfer-Optic Accessory is a Mono-Fibers holder for LAMBDA spectrophotometers. It requires a pair of Mono-Fibers, either 2- or 10-meters long. Other optodes are available upon request.



Transfer-Optic Accessory
B0509546

LAMBDA Model	Part No.
20/20Bio/40/40Bio/25/35/45	B0509546
650/750/850/850+/950/1050/1050+	L6020290

Mono-Fibers Pairs

Required for Transfer-Optic Accessory (**B0509546/L6020290**), these Mono-Fibers come in packages of two.

Wavelength	Part No.
250–900 nm (UV/Vis)	B0196912
400–2400 nm (Vis/NIR), 2 meters	B0509591

Autosamplers

S23 Autosampler

The S20 series is the next generation of high-performance, robust, and agile autosamplers designed specifically for PerkinElmer's spectroscopy platforms. The S23 autosampler is a three rack autosampler designed to meet the needs of all types of laboratories requiring:

- Capacity: up to 270 samples.
- Speed: intelligent acceleration and deceleration speed in three axes.
- Ease of use: full control through various software platforms – Syngistix for UVWinLab and SpectrumFL.

The S23 autosampler is engineered with robustness and versatility in mind, offering a mechanical Z arm that is intended to accommodate various accessories. It's equipped with proprietary crash detection, ensuring a damage-free probe.



LAMBDA Models	Part No.
20/40/20Bio/40Bio/40P/25/35/45/ 365/650/750/850/850+/900/950/1050/1050+	N0830015

* The LAMBDA 365 cannot use the external Sipper (N4101012) and the Autosampler simultaneously.

Sample Vessels

Polypropylene sample vessels are designed to provide excellent chemical resistance.



Description	Volume Capacity	Dimensions	Usage	Part No.
Sample Vessels (pkg. 500)	6 mL	12 mm x 75 mm	For Tray "E"	B0193235
Sample Vessels (pkg. 1000)	8 mL	13 mm x 100 mm	For Tray "E"	B0508901
Sample Vessels (pkg. 500)	15 mL	17 mm x 120 mm	For Tray "F"	B0193233
Sample Vessels (pkg. 500)	50 mL	28 mm x 115 mm	For Tray "G"	B0193234

Auto Sipper Accessory

The Automatic Sipper simplifies the process of filling and cleaning sample cells while improving the efficiency and accuracy of sample replacement. This kit includes an automatic peristaltic pump, a pumping cartridge, tubing, a flow-through cell (N4101052), and a computer cable. Also included is the software necessary to automate and control the Sipper's two flow channels.



Description	LAMBDA Model	Part No.
Auto Sipper Accessory	365/465	N4101012

Peristaltic Sipper "PESI"

The Peristaltic Sipper, PESI, allows you to select sampling and purging times from a keyboard. Requires, but does not include, a flowcell with a screw connector.

No PCB accessory is necessary for the LAMBDA 25/35/45/10/20/40 spectrometers.

Other LAMBDA models require the following PCB accessories:

- **B2190034** LAMBDA Bio/11/12/14.
- **B2205116** LAMBDA 650/750/850/850+/900/950/1050/1050+.

Description	Part No.
Peristaltic Sipper PESI	B2190036

Sipper Installation Kits

The Sipper Installation Kit includes a sample compartment front plate to adapt the different sipper modules.



Front Plate for Auto Sipper Accessory
N4101026

Description	LAMBDA Model	Part No.
Sipper Installation Kit	650/750/850/850+/ 950/1050/1050+	L6020291
Front Plate Tube Connection Kit	365	N4101026
Front Plate & Tube Kit Includes replacement connection tubing, washer, and fittings	365	N4101055

Tubing Kit for Peristaltic Sipper, "PESI"

This tubing kit connects the Peristaltic Sipper "PESI" accessory with the S10 AutoSampler. It includes a suction tube, a cell valve fitting assembly, PVC tubing, and silicon tubing.

Description	Part No.
Tubing Kit for Peristaltic Sipper "PESI"	B2500103

Peristaltic Pump Tubing Kit

The Peristaltic Pump tubing has an inner diameter of 2.06 mm and a wall thickness of 0.80 mm.

Description	Part No.
Tubing for Peristaltic Pump (pkg. 12)	B0190034

Total Absolute Measurement System

The Total Absolute Measurement System (TAMS) enables absolute measurement of directional Reflectance & transmittance and BRDF/BTDF measurements (characterization of the appearance of surfaces). The TAMS provides the widest wavelength range of measurement and first upgradeable detector configuration in the industry and may be used with Sphere and Direct Detectors available in Si/InGaAs, Si and Si/PbS. The wavelength ranges between 190 and 3000 nm depending on the detector for both sample and reference beams. The TAMS takes advantage of the open architecture of the LAMBDA platform, providing a solid mounting position once removing the instrument detector module and installing the TAMS in its place.



Sphere Detectors for Maximum Accuracy

Directional, Reflectance and Transmittance on coated thin and thick substrates (up to at least 12 mm), slightly curved samples, prisms and beam splitter cubes.

Description	Wavelength Range	Part No.
TAMS Sphere Detector Standard Si/InGaAs	200–2600 nm	L6310242*
TAMS Sphere Detector Enhanced Si/InGaAs	200–2500 nm	L6310255*
TAMS Sphere Detector Si/PbS	200–2600 nm	L6310243*
TAMS Sphere Detector Enhanced (Si only)	190–1150 nm	L6310244*

Standard Direct Detectors for Maximum Sensitivity

BRDF/BTDF and other scattering measurements on diffusers, patterned and diffuse coatings and materials for straylight suppression, Directional transmittance and reflectance of thin foils, directional reflectance of front surface mirrors, angular color measurements, measurement of optical filters.

Description	Wavelength Range	Part No.
TAMS Standard Direct Detector Enhanced (Si/InGaAs)	200–2500 nm	L6310254*
TAMS Standard Direct Detector (Si/PbS)	190–3300 nm	L6310246*
TAMS Standard Direct Detector (Large Si only)	190–1150 nm	L6310247*

TAMS Selection Chart

	Part No.	Description	Wavelength Range	Comments	Market Application	Types of Measurements and Samples
Sphere Detectors for Maximum Accuracy	L6310242*	TAMS Sphere Detector Standard Si/InGaAs	200–2600 nm		Architectural and Automotive Glass (ISO9050, EN410, NFRC standards), optical coatings, optical components	Directional, reflectance and transmittance on coated thin and thick substrates (up to at least 12 mm), slightly curved samples, prisms and beam splitter cubes
	L6310255*	TAMS Sphere Detector Enhanced Si/InGaAs	200–2500 nm	Has Larger detector and 2 stage TEC for greater sensitivity		
	L6310243*	TAMS Sphere Detector Si/PbS	200–2600 nm			
	L6310244*	TAMS Sphere Detector Enhanced (Si only)	190–1150 nm	Has Larger, more efficient detector maximum sensitivity	Solar cell glass and substrates, greenhouse glass	
Standard Direct Detectors for Maximum Sensitivity	L6310254*	TAMS Direct Detector Enhanced (Si/InGaAs)	200–2500 nm	Has Larger detector and 2 stage TEC for more sensitivity. Greater than 6 Abs in the NIR	Solar cell research, optical components, color measurements on specular substrates, optical materials for space applications	BRDF/BTDF and other scattering measurements on diffusers, patterned and diffuse coatings, and materials for straylight suppression. Directional transmittance and reflectance of thin foils, directional reflectance of front surface mirrors, angular color measurements, measurement of optical filters
	L6310246*	TAMS Standard Direct Detector (Si/PbS)	190–3300 nm	Recommended for measurements requiring up to 3300 nm		
	L6310247*	TAMS Standard Direct Detector Enhanced (Si only)	190–1150 nm	Our most sensitive detector for high resolution scattering measurements and for measurements involving reduced spot size. Large detector, extreme sensitivity, Greater than 6 Abs in the NIR. Due to its large size, the Large Si detector can accurately measure thicker samples (tested up to 6 mm)		

* All require TAMS Platform **L6310240**.

UV/VIS Reference Standards

These kits ensure the measurement accuracy of all of our LAMBDA instruments which in turn improves your analysis. Periodic recalibration/recertification is recommended.

Calibration Reference Standards for PerkinElmer and non-PerkinElmer Spectrometers



Photometric and Wavelength Accuracy Reference Material Set

PerkinElmer reference standards speed calibration verification of UV/Vis and UV/Vis/NIR spectrometers, providing laboratory managers with the evidence they need to pass the strictest quality audit.

A comprehensive range of certified traceable filters and sealed cuvettes fit into the standard 10 mm cuvette holder of PerkinElmer and non-PerkinElmer instruments allowing users to generate simple protocols to verify ordinate and abscissa accuracy, stray light radiation, and spectral resolution. All reference standards are certified traceable to National Institute of Standards and Technology (NIST) primary reference standards and are supplied with a calibration certificate detailing the calibration method and results.

A PerkinElmer recertification laboratory equipped with state-of-the-art instrument technology ensures a rapid turnaround service for periodic recalibration of PerkinElmer and non-PerkinElmer reference standards, allowing laboratories to maintain the requirements of their calibration SOPs.

Features and Benefits:

- Comprehensive range of reference standards
- Traceable to NIST
- Immediate availability
- Rapid recertification service for PerkinElmer and non-PerkinElmer reference standards

Photometric and Wavelength Accuracy Reference Standards Set

A set of reference standards used to verify the ordinate (photometric) and abscissa (wavelength) accuracy of UV/Vis and UV/Vis/NIR Spectrometers. Neutral density glass filters included in this kit are A2LA ISO 17025 accredited.

The set includes four glass filters mounted in precision aluminum spring mounts. The cells are designed for use with standard 10 mm cuvette holders of most UV/Vis and UV/Vis/NIR Spectrometers. There are three neutral density glass filters for checking the ordinate accuracy and a holmium oxide glass filter for checking the wavelength accuracy of a spectrometer. Each filter has an identification number. The ordinate and abscissa values of each filter are quoted in the accompanying Certificate of Calibration, nominally 1A (10%T), 0.5A (30%T) and 0.3A (50%T). Reference standards are supplied in a re-useable UV-protective storage container.

Description	Part No.
Holmium Oxide Glass Filter, Wavelength Accuracy Standard	N1010545*
Photometric and Wavelength Accuracy Reference Material Set	B0507805**

* Requires the Single Recalibration Kit (**N1010540**).

** PerkinElmer offers a service for periodic recertification of standards (**N1010539**).

Stray Light Solutions Reference Standards Set

The set of reference standards is comprised of four solutions in sealed cells – one reference and three test solutions. The cells are designed for use with standard 10 mm cuvette holders of most UV/Vis and UV/Vis/NIR Spectrometers. The test solutions, comprising sodium iodide, sodium nitride, and potassium chloride, act as a cut-off filter with a very precise wavelength. Reference standards are accompanied with a Certificate of calibration and are supplied in a re-useable UV-protective storage container.

Description	Part No.
Stray Light Solutions Reference Material Set	B2500099*

* Since UV/Vis and UV/Vis/NIR reference standards require periodic recertification, PerkinElmer offers a rapid, convenient recertification service (**N1010539**).

Pharmacopeia Solutions Reference Material Set

Reference standards to verify calibration of UV/Vis and UV/Vis/NIR Spectrometers in accordance with Pharmacopeia requirements, including:

- Ordinate (photometric) accuracy (potassium dichromate in perchloric acid)
- Abscissa (wavelength) accuracy (holmium perchlorate)
- Stray radiation level (potassium chloride)
- Resolution (toluene in hexane)

The set of reference standards is comprised of six calibrated solutions in sealed cells – two reference solutions and four test solutions. The cells are designed for use with standard 10 mm cuvette holders of most UV/Vis and UV/Vis/NIR Spectrometers. Reference standards are accompanied with a Certificate of Calibration and are supplied in a re-useable UV-protective storage container.

Description	Part No.
Pharmacopoeia Solutions Reference Material Set, containing water, toluene, holium perchlorate, potassium dichromate, perchloric acid, and potassium chloride	B2500100
Holmium Perchlorate	BUV05099
60 mg Potassium Dichromate in Perchlorate Acid, includes blank	BUV10987
European Pharmacopoeia 5.2 Addendum Kit to B2500100, contains toluene in methanol, potassium dichromate in perchloric acid (600 mg solution), and methanol	L6025049

Reference Mirror for Reflectance Spectroscopy

The disposable reference mirror for reflectance spectroscopy is required to verify the specular reflectance calibration of PerkinElmer and non-PerkinElmer reflectance accessories. This mirror cannot be recalibrated. An optional aluminum mirror with magnesium fluoride coating is a secondary standard and is calibrated according to GLP regulations in the wavelength range 250–2500 nm and includes spectral data on convenient transfer media for %RC reflection correction.

Description	Part No.
Disposable Reference Mirror for Reflectance Spectroscopy	N1010504
UV/Vis/NIR Calibrated Second Surface Reference Mirror, 50 mm by 50 mm, optional accessory	L6310204

Recertification Program for UV/Vis

To guarantee the integrity of your Reference Material set, they must be recertified at periodic intervals. PerkinElmer offers a rapid recertification process that includes, inspection and cleaning of the reference material, recertification testing using state-of-the-art and provide a certificate of the results. Fast shipment to and from our laboratory from anywhere in the world is free, and we return ship your recertified standards in ten business days or less from the time we receive them.

A recertification service for individual reference standards or non-PerkinElmer reference standards is also available. Please contact our recertification laboratory in the United States by email (PKIFILTERS@PerkinElmer.com) for availability, pricing, requests, ordering procedures and other questions.

Description	Part No.
Recertification Program for UV/Vis Calibration Reference Standards	N1010539
Recertification Program for Individual Reference Material	N1010540

Calibrated Diffuse Reflectance Standards Sets

For establishment of photometric accuracy and linearity in diffuse reflectance, reflectance calibration is NIST® traceable. Calibrated 250–2500 nm reported each 50 nm. Disc included with data each 1 nm.

Description	Part No.
1.25" Calibrated White Plate Reflectance Standard High Performance (99%)	PELA9057
2.00" Calibrated White Plate Reflectance Standard High Performance (99%)	PELA9058
1.25" Calibrated Diffuse Reflectance Standards Kit (set of 4) Reflectance factors: 2%, 50%, 75%, 99%	PELA9010
2.00" Calibrated Diffuse Reflectance Standards Kit (set of 4) Reflectance factors: 2%, 50%, 75%, 99%	PELA9011
1.25" Calibrated Diffuse Reflectance Standards Kit (set of 8) Reflectance factors: 2%, 5%, 10%, 20%, 40%, 60%, 80%, 99%	PELA9012
2.00" Calibrated Diffuse Reflectance Standards Kit (set of 8) Reflectance factors: 2%, 5%, 10%, 20%, 40%, 60%, 80%, 99%	PELA9013

Calibrated Diffuse Color Standard Sets

For establishment of photometric accuracy and linearity in diffuse reflectance mode. Reflectance calibration traceable to NIST and NPL standards. Calibrated 250–2500 nm reported each 50 nm. Disc included with data each 1 nm.

Description	Part No.
2 in. diameter Calibrated Diffuse Color Standards Kit (set of 4) includes one red, green, blue, and yellow standard	PELA9018
2 in. diameter Calibrated Diffuse Color Standards Kit (set of 4) includes one orange, purple, cyan, and violet standard	PELA9019
2 in. diameter Calibrated Diffuse Color/Reflectance Standards Kit (set of 8) includes one red, green, blue, yellow, 99%, 75%, 50%, and 2% standard	PELA9020
2 in. diameter Calibrated Diffuse Color Standards Kit (set of 8) includes one red, blue, green, yellow, orange, purple, cyan, and violet standard	PELA9021

Uncalibrated Diffuse Reflectance Standards

Description	Part No.
1.25 in. Uncalibrated White Plate Reflectance Standard High Performance (99%)	L6020318
2.00 in. Uncalibrated White Plate Reflectance Standard High Performance (99%)	L6020319

FLUORESCENCE

PerkinElmer offers a wide selection of superior quality products designed to work with your PerkinElmer instruments. Our precision designed products deliver the peace of mind that comes from knowing that you'll get the results you need.

Quick Reference Index Page

Fluorescence Lamps

PerkinElmer provides easy-to-install replacements lamps for their FL 6500 and FL 8500 spectrometers. Also available are PKI Service-installed lamps for their older instruments.

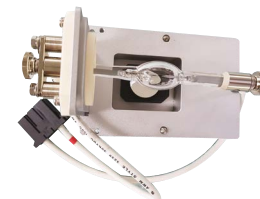

Reference Standards

To ensure your spectrometer's measurements are accurate, PerkinElmer offers kits of reference standards to support your daily checks of wavelength calibrations and signal to noise sensitivities.



Fluorescence Cells

PerkinElmer's Fluorescence cells come in a wide variety of shapes, sizes, and materials. PerkinElmer also supplies cells for specialized functionality magnetic stirring, thermostatic control, and flow-through applications.



Cell and Sample Holders

Single cell or multi-cell, micro-cell or large solid sample, variable-angle or thermostatic, PerkinElmer has the cell holder you need to support your fluorescopic analysis.

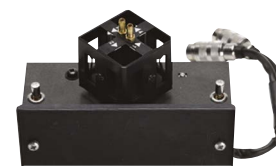

Auto Sippers and Autosamplers

PerkinElmer's Auto Sipper and Autosamplers frees you from time-consuming, repetitive steps involved with sample preparation. PKI's Auto Sipper and Autosampler accessories keep these accessories running smoothly – so you can too.



FLUORESCENCE THAT OUTSHINES EXPECTATIONS



FL 6500™ and FL 8500™ Fluorescence Spectrometers



Copyright © 2018 PerkinElmer, Inc. 400382_01 All rights reserved. PerkinElmer® is a registered trademark of PerkinElmer, Inc. All other trademarks are the property of their respective owners.

We know that high performance and reliability are top priorities for labs. We've developed a complete fluorescence solution that enables confident, precise sample testing. Designed to work as fluidly as you do, our spectroscopy instruments use interchangeable, plug-and-play accessories, intuitive software that mirrors your laboratory workflow, and support and services that validate your equipment and ensure you meet standard compliance regulations. Tackle any application challenge that comes your way.

JCANO
INGENIERÍA DE MÉXICO
Equipo de Laboratorio, Mantenimiento, Capacitación y CRM personalizado



PerkinElmer
For the Better

Fluorescence Spectrometer Instruments



FL 6500 Fluorescence Spectrometer

Pulse fluorescence spectrometer that produces high-quality results without photo-bleaching using a pulsed excitation source.

- High energy, pulsed Xenon light source and user-defined power settings that increase dynamic range while preserving integrity of samples.
- Better resolution that increases the number of spectral peaks that can be resolved, improving identification and qualification when compared to previous models.
- Provides protection from photobleaching.
- Compatible with more than twenty interchangeable accessories that are auto-recognized by the software to minimize downtime.
- Wavelength range of 200–900 nm with an accuracy of 0.5 nm and a reproducibility of 0.2 nm.
- Enables user to control the PMT voltage to prevent saturation without an attenuator.
- Maximize dynamic range with four user selectable Peak Power settings.
- Minimum Spectral resolution is 1 nm.
- Selectable Emission and Excitation slit width, as low as 0.5 nm.
- 12 slot emission filter wheels.
- Event marker.
- 21 CFR Part 11 and EU Annex 11 compliance Software.

Applications:

- Optimal system for analyzing samples susceptible to photo-bleaching. Photo-bleaching may be experienced with certain thin coatings and compounds in: Biotech, Pharmaceuticals, Cell Biology, Molecular Biology, Protein Analysis and Immunology/Enzymology.
- Phosphorescence analysis.



FL 8500 Fluorescence Spectrometer

High-sensitivity continuous wave fluorescence spectrometer capable of high sensitivity measurements at scan speeds up to 60,000 nm/min.

- High-sensitivity Xenon Arc (150 W) lamp source.
- Continuous-wave excitation source.
- Compatible with more than twenty interchangeable accessories that are auto-recognized by the software to minimize downtime.
- Wavelength range of 200–900 nm with an accuracy of 0.5 nm and a reproducibility of 0.2 nm.
- Enables user to control the PMT voltage to prevent saturation without an attenuator.
- High Sensitivity 4000:1 (RMS).
- Selectable Emission and Excitation slit width, as low as 0.5 nm.
- 12 slot emission filter wheels.
- Event marker.
- 3-D Spectra scan.
- 21 CFR Part 11 and EU Annex 11 compliance Software.

Applications:

- Testing diluted and small samples.
- Materials characterization.
- Industrial tracing and manufacturing research and development.
- Agricultural and environmental analysis.
- Analysis of LEDs, solar cells, and organic electroluminescent materials.
- Pharmaceutical QA/QC and Contract Laboratories Industrial Dye, Tracing & Printing.

Fluorescence Lamps

Xenon Continuous Wave Lamp Module

The Xenon Continuous Wave Lamp Module has two options. Both include a high-powered, Xenon Continuous Wave lamp (150 W) and an upper bracket. They are factory-calibrated and easily installed by the users. The second option, **N4202036**, includes a reflection mirror.



FL 8500 Continuous Wave Lamp Module **N4202036**

Description	Model	Part No.
Continuous Wavelength Module with Upper Bracket	FL 8500	N4202035
Continuous Wavelength Module with Upper Bracket and Reflection Mirror	FL 8500	N4202036*

* This option should only be ordered if the mirror has been broken, scratched, or contaminated.

Xenon Pulse Lamp with Silencer

The Xenon Pulse Lamp with Silencer module includes the long-lasting power-selectable Xenon pulse lamp, bracket, and silencer. Easily installed by user.



FL 6500 Xenon Pulse Lamp with Silencer **N4202020**

Description	Model	Part No.
Xenon Pulse Lamp with Silencer	FL 6500	N4202020

Replacement Lamps for Older Fluorescence Spectrometers

To maintain the original stability and sensitivity of the instrument only use PerkinElmer replacement lamps. The quartz envelopes of these lamps are pressurized and require extreme caution. Replacement by PKI Service Engineers is recommended.



Xenon Source Lamp

Description	Model	Part No.
Xenon Source Lamp, 7.3 W	LS 30/40/45/50/50B/55, LC 240	L2251157
Festoon Lamp 12 V, 3 W	LS 30/40/45/50/50B/55, LC 240	04969486*

* The Festoon Lamp is used along with the Xenon Lamp to maintain even triggering and stability.

Reference Standards

Luminescence Sample Blocks Kit

This kit assists in the day-to-day checks on reproducibility and wavelength calibrations. A set of six blocks. These blocks have the same dimension of a 10 mm pathlength cuvette. Each holds a different fluorescence material in its matrix, enabling fluorescence Calibration verification across a usable range of 290–570 nm. The kit includes the following standards (with wavelength range):



Luminescence Sample Blocks Kit **52019600**

Anthracene (360–402 nm), Naphalene (290–330 nm), Ovalene (342–482 nm), p-Terphenyl (295–338 nm), Tetraphenylbutadiene (348–422 nm), Compound 610 (440–475 nm), and Rhodamine (562–573 nm).

Description	Part No.
Luminescence Sample Blocks Kit	52019600
Ovalene, Fluorescence Standard, Individual Block	CP364460

Fluoroscopy Water Standards

Fluoroscopy Water Standards are used to identify an instrument's Signal to Noise ratio and sensitivity.



Sealed Water Sample **L2251293**

Description	Part No.
Sealed Water Sample. A stable sample of high purity water, permanently heat-sealed in a quartz cuvette. It has a usable range of 250–600 nm. A sample of distilled, de-ionized water, out-gassed and sealed under vacuum	L2251293
Sealed Water Cell. Certificate of Purity and Performance included	L2251365

Red-Sensitive Photomultiplier Tubes

PerkinElmer's Red-Sensitive Photomultiplier Tubes (PMT) offer highly sensitive measurements of small signals in the UV to NIR spectral region. Installation by a PerkinElmer Service Engineer is required.

Description	Model	Part No.
R928 Red-Sensitive Sample Photomultiplier (PMT). Provides measurements up to 900 nm	LS 45/50/50B/55	09972337
R955 Red-Sensitive Sample Photomultiplier (PMT). Offers better performance in the UV range (300–350 nm) than the R928	LS 45/50/50B/55 FL 6500/8500	09972329
R928 Standard in the 6500/8500	FL 6500/8500	N4202015*

* R928 Red-Sensitive Standard in the FL 6500/8500.

Fluorescence Cells

Standard rectangular macro cells are the most frequently-used type of spectroscopy cell for routine liquids analysis.

For full details of the properties of Quartz SUPRASIL® and Special Optical Glass see [UV/Vis Cells](#).



Macro Cells

Material	Qty.	Light Path	Outside Dim. H x W x D	Inside Width	Base Thickness	Cell Volume	Windows	Part No.
Special Optical Glass, with Lid	2	10 x 10 mm	45 x 12.5 x 12.5 mm	10 mm	1.25 mm	3.5 mL	4	B0631104
Quartz SUPRASIL, with Lid	2	10 x 10 mm	45 x 12.5 x 12.5 mm	10 mm	1.25 mm	3.5 mL	4	B0631107
Special Optical Glass, with Stopper	2	10 x 10 mm	46 x 12.5 x 12.5 mm	10 mm	1.25 mm	3.5 mL	4	B0631110
Quartz SUPRASIL, with Stopper	2	10 x 10 mm	46 x 12.5 x 12.5 mm	10 mm	1.25 mm	3.5 mL	4	B0631113

Semi-Micro Cells

Semi-micro cells have the same outside dimensions as the macro cells but the cell walls have been thickened slightly, limiting the interior sample chamber width to 4 mm. This reduces the sample requirements by 60%. Each package contains two cells.

Material	Qty.	Light Path	Outside Dim. H x W x D	Inside Width	Base Thickness	Cell Volume	Windows	Part No.
Quartz SUPRASIL, with Lid	2	10 x 4 mm	45 x 12.5 x 12.5 mm	4 mm	1.25 mm	1.4 mL	4	B0631116
Special Optical Glass, with Lid	2	10 x 4 mm	45 x 12.5 x 12.5 mm	4 mm	1.25 mm	1.4 mL	4	B0631115
Special Optical Glass, with Lid	2	10 x 2 mm	45 x 12.5 x 12.5 mm	2 mm	1.25 mm	700 µL	4	B0631119
Quartz SUPRASIL, with Stopper	2	10 x 4 mm	46 x 12.5 x 12.5 mm	4 mm	1.25 mm	1.4 mL	4	B0631118

Fluorescence Cells for Magnetic Stirrers

Cells for Magnetic Stirrers are Quartz SUPRASIL semi-micro cells and can be used in any stirred cell holder. These cells have an outside dimensions of 45 x 12.5 x 12.5 mm, an inside width of 4 mm, and a base thickness of 4.5 mm. Magnetic Stirrer Fleas (**04978499**) are sold separately.

Features include:

- Lightpath: 4 x 4 mm.
- Cell Volume: 500 µL.
- Windows: 4.

Material	Qty.	Part No.
Quartz SUPRASIL	1	B0631132
Magnetic Stirrer Fleas	6	04978499

Precision Cell for Powder Sample

The precision cell is designed with a quartz twist off cover which enables easy loading of powder or granular samples into the cell. The Precision Cell is used with the Solid Sample Holder (**N4201013**) or the Variable Angle Solid Sample Holder (**N4201014**).

Description	Part No.
Precision Cell for Powder Sample	N4201032

Quartz Cell with Low Profile Stopper

The quartz cell with low profile stopper is the only type of cell that can be used in the integrating sphere (**N4201017**) to avoid spillage or damage to the Sphere.

Description	Part No.
Quartz Cell with Low Profile Stopper	N4202030

Micro Cells

Micro cells have similar outside dimensions to Macro cells, but their cell walls have been thickened, limiting the interior sample chamber width, significantly reducing the amount of sample needed for analysis. Two cells per package.



Material	Qty.	Light Path	Outside Dim. H x W x D	Inside Width	Base Thickness	Cell Volume	Windows	Part No.
Quartz SUPRASIL, with Lid	2	10 x 2 mm	45 x 12.5 x 12.5 mm	2 mm	1.25	700 µL	4	B0631120
Quartz SUPRASIL, without Lid	2	5 x 5 mm	33.5 x 7.5 x 7.5 mm	5 mm	1.25 mm	600 µL	5	B0631123*
Quartz SUPRASIL, with Stopper	2	10 x 2 mm	40 x 12.5 x 12.5 mm	2 mm	1.25	700 µL	4	B0631122
Quartz SUPRASIL, with PTFE Stopper NS 5	2	5 x 5 mm	46 x 7.5 x 7.5 mm	5 mm	1.25 mm	850 µL	5	B0631142*

* Requires Microcell Adapter (**L2250139**). Microcuvette Adapter allows 5 mm pathlength microcells to be used in any of the cuvette holders (pkg. 4).

Ultra-Micro Cells

Ultra-micro cells use a narrower sample chamber, raising it directly into the center of the light path and masking it with black quartz. This design optimizes the use of smaller sample volumes. All Ultra-micro cells contain one cell.



Material	Qty.	Light Path	Center Height	Outside Dim. H x W x D	Aperture	Chamber Volume	Filling Volume	Windows	Part No.
Quartz SUPRASIL	1	10 x 2 mm	15 mm	45 x 12.5 x 12.5 mm	5 x 2 mm	100 µL	120 µL	3	B0631124

Flow-Through Cells

Fluorescence Spectroscopy Flow-Through cells are used for measuring samples with continuous flow or with sippers where individual samples are aspirated into the cell. All cells have center heights of 15 mm.

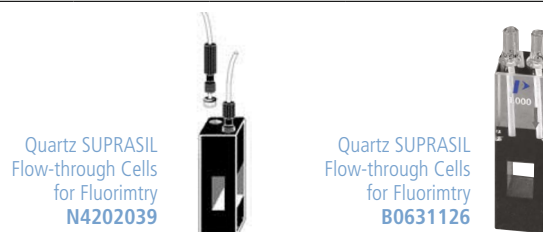

Material	Qty.	Light Path	Outside Dim.	Inside Width H x W x D	Base Thickness	Cell Volume	Windows	Part No.
QUARTZ SUPRASIL, Compact Cell	1	10 x 6.5 mm	45 x 12.5 x 12.5 mm		11 x 6.5 mm	750 µL	3	B0631126
QUARTZ SUPRASIL, Semi-Micro Cell, compact with 2 screw connectors and FEP tubing	1	3 x 3 mm	35 x 12.5 x 12.5 mm			100 µL	3	B0631133
Quartz SUPRASIL	1	10 x 4 mm	45 x 12.5 x 12.5 mm			450 µL	3	B0631127
QUARTZ SUPRASIL, This Flow Cell uses a M6 threaded connection	1	10 mm				440 µL	3	N4202039

Temperature-Controlled Cells for Fluorimetry

Material	Qty.	Light Path	Outside Dim.	Inside Width H x W x D	Base Thickness	Cell Volume	Windows	Part No.
QUARTZ SUPRASIL with stopper	1	10 x 4 mm	48 x 12.5 x 12.5 mm	4 mm	11 x 3.2 mm	1.4 mL	5	B0631125

Cell and Sample Holders

Single Cell Holder

The Single Cell Holder is included with the purchase of an FL 6500 and FL 8500 instrument. The holder can accommodate a standard cell size of 12.5 mm x 12.5 mm, with a minimum volume of 900 µL. A stopper sits at the bottom of the cell loading area which can be removed to allow the cell to sit lower in the cell holder. The beam height is 5.5 mm when the stopper is present and 11 mm when the stopper is removed.

Description	Model	Part No.
Single Cell Holder	FL 6500/8500	N4201010

Micro Cell Holder

The Adjustable Micro Cell Holder has a 8.5–15 mm beam center (z height of cell). It holds micro cell cuvettes that are easily aligned and adjusted, without a tool, so it is perfectly aligned with the beam. Cuvettes are sold separately.

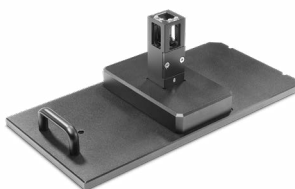

Description	Model	Part No.
Micro Cell Holder	FL 6500/8500	N4201015

Solid Sample Holder

The Solid Sample Holder enables the measurement of high-concentrated liquids, powders, films, paper and plastic samples. For solid samples, the maximum thickness is 17 mm and the maximum length is 250 mm.

Description	Model	Part No.
Solid Sample Holder	FL 6500/8500	N4201013*

* Measurements of powder samples requires the Precision Cell for Powder Samples (N4201032), sold separately.

Variable Angle Solid Sample Holder

The Variable Angle Solid Sample holder rotates a full 360-degrees enabling the measurement of high-concentrated liquid, powder, film, paper and plastic. Ideal for measuring highly concentrated liquid, powder, film, paper, and plastic sample's with a maximum thickness of 13 mm and maximum length of 140 mm.

Description	Model	Part No.
Variable Angle Solid Sample Holder	FL 6500/8500	N4201014*

* Measurements of powder samples requires the Precision Cell for Powder Samples (N4201032), sold separately.

Absorbance Module

The Absorbance Module enables rapid absorbance measurements in the ultraviolet-visible region and has a range of up to 2.5 absorbance units. The module includes an integrated detector and stirrer with four settings.

Description	Model	Part No.
Absorbance Module	FL 6500/8500	N4201018

Cell Changers

4-Position Cell Changer

The 4-Position cell changer accommodates up to 4 cells simultaneously and accommodates cells with a standard cell size of 12.5 x 12.5 mm and a minimum volume of 900 µL. FL 6500/8500 only.

Description	Part No.
4-Position Cell Changer	N4201025

Thermostating Accessories

Ideal for Polarization Studies, Protein Folding and DNA Melting

Changes in temperature affect fluorescence intensity. A simple, inexpensive and accurate way to control sample temperature is to use a thermostatable cell holder through which water from an external water-bath can be circulated. For temperature ramping studies and experiments where more rapid heating and cooling is required, a single-cell Peltier-thermostatted accessory is available.



4-Position Thermostatted Automatic Cell Changer

4-Position Thermostatted Automatic Cell Changer

The 4-Position Cell Changer accommodates four square, 10 mm pathlength cells or four micro-cells with adapters. All positions are stirred simultaneously. Includes six stirrer fleas.

Description	Model	Part No.
4-Position Thermostatted Automatic Cell Changer	LS 45/50/50B/55	L2250134*

* The LS 45 requires, but does not include, the Accessory Kit (**L2250162**).

Single-Position, Thermostatted Cell Holder

Water-thermostatted cell holder for a 10 mm pathlength cell. This cell holder comes as standard with the LS 45 and LS 55.

Description	Model	Part No.
Single-Position Thermostatted Cell Holder	LS 45/50/50B/55	L2250140
Single-Position Thermostatted Cell Holder, with Stirrer	LS 45/50/50B/55	L2250141*

* Includes six stirring fleas (**04978499**).

Biokinetics Accessory

The Biokinetics Accessory is a magnetically stirred single-cell holder with a built-in temperature sensor (0–100°C) and an event marker. Requires an external water-bath (not included). Accommodates 10 mm pathlength cuvettes and includes six stirrer fleas (**04978499**).

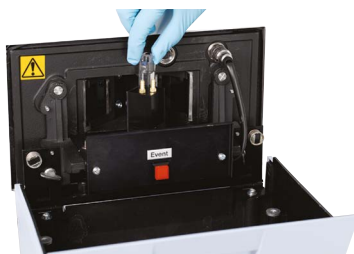

Biokinetics Accessory for LS 50/45/55

Requires Accessory PCB Kit (**L2250162**) for use with LS 45.

Description	Model	Part No.
Biokinetics Accessory	LS 45/50/50B/55	L2250145

Low-temperature Luminescence Accessory

For cooling samples to liquid nitrogen temperature. Used for measuring fluorescence or phosphorescence. Includes a pack of five sample tubes (**52126027**).

Low-temperature Sample Tubes

Description	Pkg.	Part No.
Low-Temperature Luminescence Accessory		L2250136*
Low-Temperature Sample Tubes	5	52126027

* This accessory is not compatible with the LS 45.

Thermostating Accessories for the FL 6500 and FL 8500

Single Cell Water-Jacketed Holder

The Water-Jacketed Single Cell Holder enables temperature control using an optional water bath to keep the sample at a desired temperature.

Description	Part No.
Single Cell Water-Jacketed Holder	N4201011

Single Cell Water-Jacketed Holder with Stirrer

The Water-Jacketed Single Cell Holder with Stirrer enables temperature control using a water bath (not included) to keep samples at a desired temperature and software controlling stirring of the solution with 4 stirrer settings.



Description	Part No.
Single Cell Water-Jacketed Holder with Stirrer	N4201012

Micro Cell Water-Jacketed Holder with Stirrer

The Water-Jacketed Micro Cell Holder with Stirrer enables the user to analyze samples as low as 10 µL.



Description	Part No.
Micro Cell Water-Jacketed Holder with Stirrer	N4201016

Low Temperature Sampling Accessory

The Low Temperature Sampling Accessory enables flow control of liquid nitrogen through an automatic valve with a controllable temperature range down to -196°C ~RT. The accessory includes a Liquid Nitrogen Reservoir (2L), a cuvette, an accessory cover, cover for alignment, and teflon rod. Supports the FL 6500 and FL 8500 spectrometers.



Description	Part No.
Low Temperature Sampling Accessory	N4201045

Single Cell Peltier With Stirrer

The Single Cell Peltier with Stirrer enables optimal temperature control with stirring of samples. Used in thermal denaturation, kinetics and other applications where precise temperature control is necessary. It comes with full software control of temperature controlled through Spectrum FL software. Also has a built-in radiator that maintains temperature of circulating coolant. Includes a Peltier controller with single cell holder and 2 temperature probes.

- Temperature Control Range: -5–100°C.
- Temperature Accuracy: $\leq \pm 0.1^\circ\text{C}$.
- Temperature Control Precision: $\leq \pm 0.1^\circ\text{C}$.
- Coolant cooling system and N₂ gas injection inlet/outlet included.
- Multi-step ramping and ramping rate control included.
- Supports Melting Temperature Calculation function.
- Included stirring bead (pkg. 5) (**N4202032**) sold separately.

Description	Part No.
Single Cell Peltier with Stirrer	N4201029

4-Position Water-Jacketed Cell Changer

The 4-Position Water-Jacketed Cell Changer accommodates up to 4 cells simultaneously and enables temperature control through a water bath (not included) to maintain samples at the desired temperature. The cell changer can accommodate cells with a standard size of 12.5 x 12.5 mm and a minimum volume of 900 μL .

Description	Part No.
4-Position Water-Jacketed Cell Changer	N4201026
4-Position Water-Jacketed Cell Changer with Stirrer	N4201027
Optional Stirring Bead (pkg. 5)	N4202032*

* Sold separately.

4-Position Multi-Cell Changer

The 4-Position Peltier Multi-Cell Changer accommodates up to four cuvettes/cells simultaneously and enables optimal temperature control of samples. It contains a built-in radiator that maintains temperature of circulating coolant. It includes a Peltier controller with 4-Position Multi-Cell Changer and 2 temperature probes.

- Temperature Control Range: -5–100°C.
- Coolant cooling system and N₂ gas injection inlet/outlet included.
- Multi-step ramping and ramping rate control included.
- Support Melting Temperature Calculation function.

Description	Part No.
4-Position Peltier Multi-Cell Holder	N4201030

Peltier Powder Sampling Accessory

The Peltier powder sampling accessory enables temperature-controlled fluorescence measurements of powders. Supports Melting Temperature Calculation Function. Multi-Step Ramping and Ramping Rate Control enabled

Included is a Peltier controller with single powder sampling accessory.

- Temperature Control Range: -5–100°C.

Description	Part No.
Peltier Powder Sampling Accessory	N4201034

Thermostatic Accessory for Microplate Reader

The Thermostatic Accessory for the Microplate Reader can control the temperature of the Microplate Reader Accessory (**N4201024**) using either a water bath or Peltier controller (**N4100040**).

Accessory's Temperature Range:

- With water bath: Room temperature to 100°C.
- With Peltier Controller: -5–100°C.

Description	Part No.
Thermostatic Accessory for Microplate Reader	N4201046

Fluorescence Sampling Accessories

Remote Fiber Optic Accessory

The Remote Fiber Optic Accessory allows you to make the measurement at the sample, without needing to take the sample to the instrument. Includes bifurcated synthetic fused-silica fiber-optics (1 m in length), which operate over the range 280 – 800 nm, and beam transfer holder which mounts in the spectrometer. This accessory is ideal for remote, non-destructive testing of fluorescent papers and fabrics, or remote sampling of hazardous materials. Compatible with the LS 45/50/50B/55 spectrometers.



Description	Model	Part No.
Remote Fiber Optic Accessory	LS 45/50/50B/55	L2250144

Total Emission Accessory

The Total Emission Accessory enhances the sensitivity of the fluorescence detection for samples with weak emission, and is recommended for bioluminescence and chemiluminescence experiments. The accessory uses a plane mirror that swings into place in front of the emission monochromator so that the total fluorescence of the sample can be measured.

The use of cut-off emission filters is recommended to reduce emission from other wavelengths. Five software-controlled emission filters are supplied with the LS 55 spectrometers. Supports the LS 50/50B/55 spectrometers.

Description	Model	Part No.
Total Emission Accessory	LS 50/50B/55	L2250101*

* Requires installation by a PerkinElmer service engineer (N0207173).

Front-Surface Accessory* – For Measurements on Solids, Powders and Viscous or Opaque Liquids

The simple-to-use Front-surface Accessory extends your measurement capabilities to a wide variety of solid and semi-solid samples, including powders, paper, plastic films, cloth samples, TLC plates, gels and turbid liquids. Adjustable for optimizing sensitivity. The accessory can be used with the LS 45/50/50B/55 spectrometers.



Features and Benefits:

- Used for fluorescence and phosphorescence measurements
- Sample can be placed in the accessory directly or held in the synthetic fused silica window powder holder
- Ultra-small volumes or viscous samples can be sandwiched between the two windows
- Opaque and turbid samples can be measured in small cuvettes (under 10 mm)

Description	Part No.
Front-Surface Accessory	52123130*
Powder Sample Holder For use with Front Surface Accessory (52123130)	52123164
Synthetic Fused Silica Window For Powder Sample Holder	52123814

* Includes Powder Sample Holder (52123164).

Filters and Accessories

Fast Filter Accessory

The Fast Filter Accessory enables the analysis of rapid intracellular ion movements into and out of the cells (signal transduction) using ratiometric fluorescent probes. It rapidly rotates a paired set of bandpass filters (not included) aligned to the fluorophore under investigation. Bandpass filters are easily mounted and interchanged by customers. This accessory has temperature control capabilities and works with a magnetic stirrer.

Description	Part No.
Fast Filter Accessory	N4201028

Filters for Fast Filter



The Polarizer Filters measure the polarization of samples via the filter wheel. Easily installed into the inner filter wheels of the FL 6500 and FL 8500, these filters aid in the measurements of polarization and anisotropy.

Description	Part No.
FURA2 Filters – Excitation: 340/380 nm, Emission: 510 nm	N4201035
INDO1 Filters – Excitation: 350 nm, Emission: 400/480 nm	N4201036
Polarizer – Vis Range (Wire Grid Polarizer)	N4201037
Polarizer – UV-Vis Range (Wire Grid Polarizer)	N4201038

Precision Polarizer Accessory

The precision polarizer accessory enables polarization and anisotropy measurements at multiple polarization angles and includes manually rotatable polarizers for excitation and emission. The usable wavelength range is 250–900 nm. Supports the FL 6500 and FL 8500.

Description	Part No.
Precision Polarizer Accessory	N4201023

Filters for Filter Wheel



Description	Part No.
External 590 nm Emission Filter	N4201039
External 610 nm Emission Filter	N4201040
External 665 nm Emission Filter	N4201041
Polarizer Filter, Vis Range 400–700 nm, 1 set of Excitation filters	N4201022
Polarizer Filter, UV-Vis Range 300–800 nm, 2 sets of Excitation Filters	N4201019
V-/H-Polarizer Emission Filter (UV Vis), 2 sets of Emissions Filters	N4201042
V-/H-Polarizer Emission Filter (Vis), 1 set of Emissions Filters	N4201043

Please inquire about additional Emission and Excitation (ϕ 12.5 mm X 3 mm) filters not listed, including custom filters.

Auto Sippers and Autosamplers

PerkinElmer's Auto Sippers and Autosamplers free you from the time-consuming, repetitive steps involved with introducing samples to the instruments for analysis.

Auto Sipper

The auto sipper includes a front plate, FL flow cell, an automatic peristaltic pump, a pump cartridge, tubing, and a Computer Interface cable. Compatible with the FL 6500 and FL 8500.

Description	Part No.
Auto Sipper	N4201031

Sipper Cell and Pump Accessory

The Sipper Cell and Pump accessory includes a synthetic, fused-silica flow cell and a computer-controlled peristaltic pump. The flow cell is fitted with FEP in/outlet tubes. Pump tubing is also included. Compatible with the LS 45/50/50B/55.

Description	Part No.
Sipper Cell and Pump Accessory	L2250135*
Sipper Flowcell, 1.5 mm square section, 25 μ L	L2251223
FEP Inlet Tube, 0.7 mm ID	L2151203
FEP Outlet Tube, 1.0 mm ID	L2151204

* Requires the LS 45 PCB Accessory Kit (**L2250135L**) and installation by a PerkinElmer Service Engineer (**N0207173**).

Autosamplers

Autosamplers are a computer-controlled, multipurpose sampling system. They automate standard and sample introduction for instrument calibration and sample analysis, extending the spectrometer's capabilities to those of a fully automated analytical workstation.



Description	Model	Part No.
S23 Autosampler	FL 6500/8500	N0830015
Autosampler/Sipper Connection Kit	FL 6500/8500	N4202040*
S10 Fluorescence Liquid Autosampler, allows user to make unattended measurements of liquid samples	LS 45/50/50B/55	N2020010**

* This kit is required to connect the S23 to the FL 6500/8500.

** Requires, but does not include, the software, BL Studio, (**L2258003**) and a semi-micro flow through cell (**B0631133**).

Autosampler Supplies

These Autosampler trays and tubes support the S10 Autosampler (**N2020004**). The trays range in size from 29–90 sample positions, and the sample tubes hold either 5 or 8 mL.

Description	Part No.
S10 Autosampler Sample Tray, 90 locations The 90 location autosampler sample tray has a 13 mm diameter and is used with 6 mL and 8 mL sample tubes	B3140617
S10 Autosampler Sample Tray, 60 locations The 60 location autosampler sample tray has a 16 mm diameter and is used with 50 mL sample tubes	B3140618
S10 Autosampler Sample Tray, 21 locations The 21 location autosampler sample tray has a 30 mm diameter and is used with 50 mL sample tubes. It also includes 1 location for a wash tube	B3140621
S10 Autosampler Sample Tray, 29 locations The 29 location auto sampler sample tray has a 16 mm diameter and is used with 15 mL sample tubes. It also includes 9 locations with a 30 mm diameter and 1 location for a wash tube	B3001647
Sample Tube, 5 mL Includes 500 polypropylene 5 mL tubes without screw caps	B0193235
Sample Tube, 8 mL Includes 1000 polypropylene 8 mL tubes without screw caps	B0508901

Autosampler Sample Tubes

The injection port includes a 100 μ L syringe and can be used with the Single Cell Holder Water-Jacketed with Stirrer (**N4201012**), the Micro Cell Holder Water-Jacketed with Stirrer (**N4201016**) and the 4-Position Cell Changer Water-Jacketed Holder with Stirrer (**N4201027**).



15 mL Sample Tubes
B0193233

Description	Part No.
15 mL Sample Tubes Includes 500 polypropylene 15 mL tubes with red flat caps	B0193233
50 mL Sample Tubes Includes 500 polypropylene 50 mL tubes with red flat caps	B0193234

Specialty Accessories and Consumables

Rapid Mixers

These Rapid Mixers use a stopped-flow technique to enable monitoring of kinetics reactions for the FL 6500/8500.



Description	Part No.
Manual Rapid Mixing Accessory	N4104014*
Rapid Mixing Accessory with Pneumatic Drive	N4104015*
Rapid Mixing Accessory Cover	N4201020

* Requires Rapid Mixing Accessory Cover for use with the FL 6500/8500.

Fiber Optic Probe

The Fiber Optic Probe offers a compact and convenient solution for the measurement of absorbance and fluorescence in a wide variety of sample medias, such as liquid and powder samples. It has a wavelength range of 190–900 nm, with a probe diameter of 3.14 mm and an long immersing probe length of up to 70 mm.

Description	Model	Part No.
Fiber Optic Probe	FL 6500/8500	N4201021

Integrating Sphere

The Integrating Sphere enables the measurement of absolute quantum yield for liquid and powder samples. The integrating sphere is used with the Quartz Cell with Low Profile Stopper (**N4202030**).



Description	Model	Part No.
Integrating Sphere	FL 6500/8500	N4201017

Microplate Reader Accessory

The Microplate Reader Accessory enables measurements of samples in 4, 6, 12, 24, 48, 96, & 384 well plates for the FL 6500/8500.



Description	Part No.
Microplate Reader Accessory	N4201024

Dust Filters

These 80 mm Dust Filters come in a package of 4 and are used with both the FL 6500 and FL 8500. For standard labs, we recommend changing every 6 months to ensure the health of the instrument and quality of the data.

Description	Part No.
Dust Filters	N4202034

LC Flowcell Accessory

This flowcell can replace the standard cell holder on a High-Pressure Liquid Chromatograph, allowing you to detect trace components eluted from liquid chromatographs. At selected excitation and emission wavelengths, you can use your fluorescence spectrometer as a detector to monitor fluorescence continuously. This accessory includes a synthetic, fused-silica flowcell and two FEP in/outlet tubes. Compatible with the LS 45/50/50B/55.

Description	Part No.
LC Flowcell Accessory, Flowcell and Tubing	L2250138
LC Flowcell, 1.3 mm square section, 16 mL	L2151202
Sipper Cell, Replacement Flow-Through Cell for LS 55, 25 uL	L2251223
FEP Inlet Tube, 0.4 mm	L2151202
FEP Outlet Tube, 0.7 mm	L2151203

Well Plates

These well plates are used with the Microplate Reader.

Description	Qty.	Part No.
White Optiplate 96 Well Plate with Flat Bottom	50	6005290
White Optiplate 96 Well Plate with Flat Bottom	200	6005299
Black Optiplate 96 Well Plate with Flat Bottom	50	6005270
Black Optiplate 96 Well Plate with Flat Bottom	200	6005279

Well Plate Reader Accessory

The Well Plate Reader accessory provides top reading facility when measuring fluorescence and time-resolved fluorescence or phosphorescence in 6-, 12-, 24-, 48-, or 96-Position well plates. It also supports luminescence microdensitometry of TLC plates and electrophoresis gels. This reader does not support chemiluminescence or bioluminescence measurements. Compatible with the LS 50/50B/55.

Description	Part No.
Well Plate Reader	L2250042*

* Not compatible with the LS 45.

Cell Holder Cap

The sample cell holder cap is used with the integrating sphere (**N4201017**).

Description	Part No.
Cell Holder Cap	N4202031

Stirring Bead

Stirring beads are used for stirring accessories, like the Single Cell Holder Water-Jacketed with Stirrer (**N4201012**), Micro Cell Holder Water-Jacketed with Stirrer (**N4201016**) and the 4-Position Cell Changer Water-Jacketed Holder with Stirrer (**N4201027**).

Description	Part No.
Stirrer Beads (pkg. 5)	N4202032

ELEMENTAL ANALYSIS

PerkinElmer offers a wide selection of superior quality products designed to work with your PerkinElmer instruments. Our precision designed products deliver the peace of mind that comes from knowing that you'll get the results you need.

Quick Reference Index Page

Reagents and Calibration Standards

Only the best reagents and calibration standards assure optimum analyser performance. PerkinElmer reagents and standards are of high quality and designed specifically for your CHNS/O instrument.



Tubes and Receptacles

Designed to meet stringent specifications, PKI's Elemental Analysis Tubes are made of high quality fused Quartz and pressure tested for weak spots and airtight connections.



Replacement Tube Fittings

PerkinElmer offers replacement parts for the various hardware fittings required to connect glassware to your Elemental Analyzer.

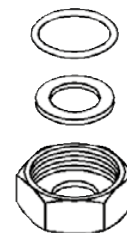

Capsules and Consumables

PerkinElmer offers a wide variety of capsules, pans, and covers – and the sealers to close them – to satisfy every EA sampling requirement.



Valve Spare Parts

To ensure proper gas flow, regular maintenance of the Elemental Analyzer valves is required. PerkinElmer has you covered.





2400 Series II CHNS/O Elemental Analyzer

PROVEN PERFORMANCE RELIABLE RESULTS

Characterize a wide variety of samples through the determination of carbon, hydrogen, nitrogen, sulfur, and oxygen content with the PerkinElmer 2400 Series II CHNS/O Elemental Analyzer. Whether you are analyzing samples in the pharmaceuticals, polymers, chemicals, environmental, or energy industry, the 2400 Series II CHNS/O Elemental Analyzer is a proven instrument to deliver the rapid and reliable results you need to ensure a productive lab.

JCANO INGENIERIA DE MÉXICO:
Priv. Brunel Mz. 1 Lt. 5 Cs 4-B Fracc. Quinta Versailles C.P. 55767 Tecámac, Edo. De México
Correo: mcano@jcanoingenieria.com
Página Web: <https://jcanoingenieria.com>
Tel: 55 3996 2586
WhatsApp: 55 7129 9832
Facebook: <https://www.facebook.com/JCanoIngenieria>



Elemental Analysis Instruments

2400 Series II CHNS/O Analyzer

Proven instrument based on the classical Pregl-Dumas method for the rapid determination of Carbon, Hydrogen, Nitrogen, Sulfur, or Oxygen content in organic and other types of materials.

The 2400 Series II offers multiple modes of analysis:

- CHN** Uses high quality reagents to ensure complete combustion and removal of interfering elements such as chlorine. Average CHN analysis time: 6 minutes
- CHNS** Performs sulphur analysis as well as the conventional CHN analyses. Average CHNS analysis time: 8 minutes.
- Oxygen** Employs pyrolysis to analyze samples for oxygen. Average CHNS/O analysis time: 4 minutes.

The CHNS/O Analyzer performs both static and dynamic combustion with a temperature range of 100–1100° C. It has a Thermal Conductivity detector and uses Frontal Chromatography to identify the separated gases.

- The optional Column Switching Accessory (CSA) makes switching to the Oxygen mode very convenient.
- Uses a 60-Position autosampler for unattended operation.
- Uses Helium or Argon as a carrier gas; Oxygen as the combustion gas; a mixture of 5–8% Hydrogen in Helium as the pyrolysis gas; and Air, Nitrogen, or Argon as the pneumatic gas.
- Accommodates samples up to 500 mg.
- EA 2400 Data Manager software for easy data handling.
- Easy access to all components for routine care and maintenance.



The 2400 Series II CHNS/O Analyzer comes standard with an autosampler (**N2410101**), the Sample Handling Kit (**N2410146**), a Tube Holder (**N2410267**), the 2400 Accessory Kit (**N2410510**), and the Users Manual.

Applications:

- CHN mode: Used to analyze virtually any sample type.
- CHNS mode: Simultaneous determination of Carbon, Hydrogen, Nitrogen, and Sulfur in organic materials.
- Oxygen mode: Automatic determination of Oxygen in organic materials by pyrolyzation of the sample.
- Pharmaceuticals, polymers, chemicals, food, environmental and energy. Either as solids or liquids including volatile and viscous samples.

PerkinElmer 2400 Series II CHNS/O Elemental Analyzer

The CHN and CHNS modes are based on the classical Pregl-Dumas method where samples are combusted in a pure oxygen environment, with the resultant combustion gases measured in an automated fashion.

The 2400 Series II system is comprised of four major zones: Combustion Zone, Gas Control Zone, Separation Zone, Detection Zone.

In the Combustion Zone, samples encapsulated in tin or aluminum vials are inserted automatically from the integral 60-Position autosampler or manually using a single-sample auto injector.

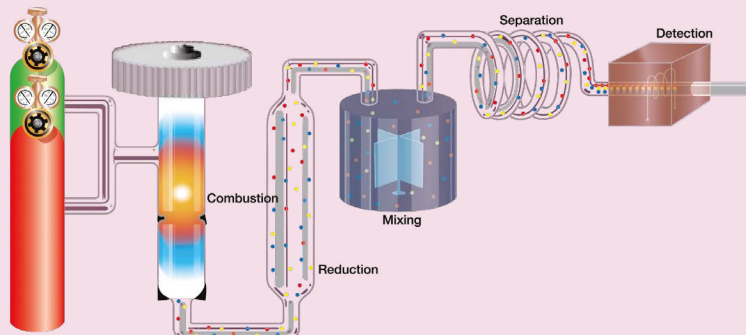

Elemental Analysis Kits

Depending on the type of analysis you do, the CHNS/O Elemental Analyzer series 2400 requires at least one of the kits listed below.

Initial Oxygen Analysis Kit

If your CHNS/O Elemental Analyzer has built-in column switching capabilities, an Oxygen Analysis kit is required, in addition to a CHN or CHNS kit. You have a choice of the Initial Oxygen Analysis kit, lasting for approximately 1000 uses, or the Oxygen Tube Kit, lasting approximately 250 runs. Both kits provide prepacked tubes.



N2410696

Description	Part No.
Initial Oxygen Analysis Kit	N2410323
Oxygen Tube Kit	N2410513

Oxygen Kits Contents

Description	Initial Oxygen Analysis Kit	Oxygen Tube Kit	Part No.
Oxygen Pyrolysis Tube	X	X	N2410696
Scrubbing Tubes, Argon-Sealed	X	X	N2410697
Oxygen Reduction Furnace Tube	X		N2410698
Standard Tin Capsules	X		N2411255
Quartz Tube Insert	X		N2411401

CHN Kits

To fully support CHN analysis using the Elemental Analyzer 2400 series, PerkinElmer offers a choice of CHN kits: CHN Initial Analysis kit or the CHN Reagent Kit. The Reduction tubes in the Reagent are pack your own Reduction kit. Both kits last for approximately 2000 uses.



Quartz Tube Insert N2411401

Description	Part No.
CHN Initial Analysis Kit	N2410506
CHN Reagent Kit	N2410683

CHN Kits Contents

Description	Initial Analysis	Reagent	Part No.
Acetanilide		X	02401121
0.5 x 6 in. Silver Gauze Strip		X	N2410145
Reduction Tube-Silica	X		N2410694
Combo Tube-Silica	X		N2410695
Std Tin Capsule	X	X	N2411255
Quartz Tube Insert	X		N2141401
Reduction Tubes, not pre-packed		X	N2410681

CHNS Kits

To fully support CHNS analysis using the 2400 Elemental Analyzer 2400 series, PerkinElmer offers a choice of CHNS kits: CHNS Initial Analysis kit and the CHNS Combo/Reduction Kit. The Initial Analysis kit supplies pre-packed tubes, while the tubes in the Combo/Reduction kit are a pack-your-own. Both kits last for approximately 500 runs.



Standard Tin Capsule Kit N2411255

Description	Part No.
CHNS Initial Analysis Kit	N2410507
CHNS Combo/Reduction Kit	N2410682

CHNS Kits Contents

Description	Initial Analysis	Combo/Reduction	Part No.
Cuprin, Reagent		X	02401362
Reagent Kit EA-6000, 210 g		X	N2410692
Oxidation/Reduction Tube	X		N2410693
Oxygen Reduction Reaction Furnace Tube	X		N2410698
Standard Tin Capsule	X	X	N2411255
Quartz Tube Insert	X	X	N2411401
Oxygen Quartz Reduction Tube, 11 mm		X	N2411300
Quartz Combustion Tube		X	N2411514

System Extension Kits

The System Extension kits offer replacement tubes for the most frequently used tubes during CHN, CHNS, and Oxygen analysis. The CHN and CHNS Extension kits offer customers the option of packing their own Reduction and Combustion tubes. These kits require, but do not include, quartz wool.

Description	Part No.
CHN Initial System Extension Kit This pack-your-own Reduction Tube kit includes three bottles of Granular Copper+, 454 g (N2400117); a Tin Capsule kit, 960 count, (N2410155); and three CHN Reduction tubes, (N2411291)	N2410234
CHNS Initial System Extension Kit (960 runs) This pack-your-own Combustion/Reduction Tube kit includes two Copper+ Wires, (N2401362); a Tin Capsule kit, 960 count (N2410155); EA-6000 Reagent, 70 g, (N2410278); a Quartz Tube Insert (N2411401); and a CHNS Combustion/Reduction tube, (N2411514)	N2410322
Initial System Extension Kit of Oxygen Analysis (1000 runs) This kit of pre-packed tubes includes one Oxygen Pyrolysis tube (N2410696); four Scrubbing Tubes, (N2410697); one Reduction Furnace Tube (N2410698) a Tin Capsule kit, 1056 count (N2411255); and a Quartz Tube Insert (N2411401)	N2410323

Solid Sample Handling Kit

The Solid Sample Handling Kit comes with the basic tools needed to conduct CHNS/O analysis for solid or liquid samples. Kit includes a Micro Hayman spatula (N2401286); Single-Quill brushes (pkg. 12) (N2401296); one pair of Hook Tweezers (N2401296); one pair of Flat Forceps (N2401296); a pair of Flat Forceps (N2401296); and a Pedestal for Sample Capsules (N2411267).



Description	Part No.
Solid Sample Handling Kit	N2410146

Liquid Sample Sealing Kit

The Liquid Sample Sealer Kit is intended for use with volatile, non-viscous, and non-corrosive samples. The kit includes one Capsule Sealing Unit, one Magazine (holds 4- and 30 µL capsules), and an instruction manual.

Description	Part No.
Liquid Sample Sealing Kit	N2410108*
Capsule Magazine	B0501078

* This kit requires, but does not include, Tin/Aluminum Capsules, 4 µL (N2400642) or 30 µL (N2400709).

PE 2400 Series II Accessory Kit

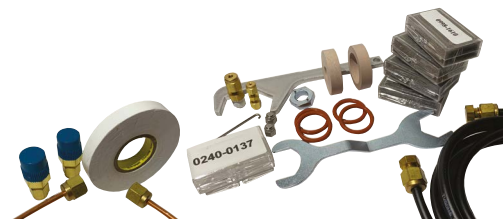

This Accessory Kit comes standard with Elemental Analyzer. It is also available as a source of replacement and maintenance parts. The kit includes one Hydrogen Restrictor accessory (N0090037); one Spanner Wrench Valves (N2401294); Filter Disks, 11 mm, (pkg. 12) (N2401375); twelve Black Viton, 25 mm, 0.421 ID O-Rings (N09902029); four red silicone O-Rings 0.859 ID (N09902188); two End Cap Plugs (N09903174); one End Cap Union (N09903422); a Double Open End Wrench, 11 mm (N09907204); an Allen Wrench, 9/64 in (N09907207); two Slow Blow Fuses, 0.5-Amp, 250V, (N09981610); two Slow Blow Fuses, 0.1-Amp, 250V (N09981611); two Slow Blow Fuses, 0.375-Amp, 250V, (N09981619); two Slow Blow Fuses, 0.75-Amp, 250V (N09981788); three plastic Gas Line Assemblies (N2410147); one Copper Gas Line Assembly (N2410170); one Wrench, 25 mm (N2411144); one Retrieving Wire (N2411274); one Ceramic Ring Combustion Tube, 25 mm (N2411341); and one Ceramic Ring Reduction Tube, 11 mm (N2411342).

Description	Part No.
PE 2400 Series II Accessory Kit	N2410510

PE 2400 Series Maintenance Kit

This kit supplies replacements for consumable parts, such as O-Rings and valves. This kit is recommended if you anticipate heavy usage of the EA 2400 Analyzer. Included in this kit are three Washer O-Rings (N2401042); one Skinner O-Ring (N2402089); three Black Viton, 25 mm, 0.421 ID O-Rings, (N09902029); three O-Rings Black Viton, 25 mm, 0.859 ID (N09902048); two Viton O-Rings, 0.614 ID (N09902123); one Viton O-Ring, 3.487 ID (N09902133); two red silicone O-Rings 0.859 ID (N09902188); one Solenoid Gas Line Filter (N09903673); one Stubby Spring Plunger (N09908854); one Solenoid Open Valve Accessory (N2411088); two 25 mm Glass Tube Washers (N2411118); and five Normally Closed Valve Plunger (N2411257).

Description	Part No.
PE 2400 Series Maintenance Kit	N2410152

Zirconia Cloth Kit

This kit protects combustion tubes when using Aluminum capsules. Instructions included.

Description	Part No.
Zirconia Cloth Kit	N2410168

Reagents and Calibration Standards

The best way to assure consistent and accurate results from your PerkinElmer Organic Elemental Analyzer is to use only the highest quality grade of reagents. Our scientists select the purest raw materials, condition, and test them to guarantee the best possible results.



PerkinElmer genuine reagents will assure consistent and accurate results

Description	Part No.
EA-1000, (50 g)	N2410092
EA-1000, (3 x 50 g)	N2410166
Silver Tungstate/Magnesium Oxide, (100 g)	02401344
Silver Tungstate/Magnesium Oxide, (3 x 100 g)	N2410165
Silver Vanadate, (40 g)	02401117
Silver Vanadate, (3 x 40 g)	N2410164
EA-6000, (50 g)	N2410278
EA-6000, (5 x 50 g)	N2410331
Platinized Carbon, (10 g)	02400119
Copper Plus, (454 g)	02400117
Copper Plus, (10 x 454 g)	N2410157
Copper Plus – Wire Form, (454 g)	02401362
Copper Plus – Wire Form, (5 x 454 g)	N2410332
Copper for Nitrogen, (454 g)	N2411527
Copper for Nitrogen, (10 x 454 g)	N2410518
Copper Oxide – Wire Form, (454 g)	02401092
Alpha Aquasorb, (25 g)	N2410277
Colorcarb, (100 g)	02400115
Colorcarb, (3 x 100 g)	N2410188
Magnesium Perchlorate, (454 g)	02401119
Magnesium Perchlorate, (3 x 454 g)	N2410191
Thermolite, (100 g)	02400815
Chromosorb W 45-60 Mesh	N2411701

Calibration Standards

Description	Size	Part No.
Acetanilide (C=71.09%/H=6.71%/N=10.36%)	2 g	02401121
Benzoic Acid (C=68.85%/H=4.95%/N=26.20%)	4 g	02401120
Cystine (C=29.99%/H=5.03%/N=11.66%/S=26.69%)	4 g	N2410324
EDTA (C=41.04%/H=5.51%/N=9.56%)	100 g	N2410325
Sulfamic Acid (Conditioning aid for CHNS analysis) (C=51.19%/H=5.07%/N=20.14%)	10 g	N2410501
Cyclohexanone 2-4 Dinitrophenylhydrazone	1 g	02401347
Combustion Standards Kit		02400083
Kit includes: One of each Benzoic Acid (02401120), Acetanilide (02401121) and Cyclohexanone 2-4 Cyclohexanone (02401347)		

Tubes and Receptacles

Elemental Analysis Tubes

PerkinElmer tubes are composed of pure fused quartz which is 99% SiO₂. Fused quartz has been chosen because of its very high purity and low thermal expansion rate. All combustion tubes are pressure-tested to eliminate any tubes which might contain weak spots. In addition, stringent specifications are used to ensure that the combustion tubes fit in an airtight connection when placed in the analyzer.



Combustion and Pyrolysis Tubes

Type	Material	Analyzer	Mode	Qty.	Part No.
Combustion	Quartz	2400	CHN	1	N2411264
Combustion	Quartz	2400	CHN	3	N2410212
Combustion	Quartz	2400	CHN	10	N2410153
Combustion/ Reduction	Quartz	2400	CHNS	1	N2411514
Combustion/ Reduction	Quartz	2400	CHNS	5	N2410330
Combustion/ Reduction	Stainless Steel	2410	Nitrogen	1	N2421070
Pyrolysis	Quartz	2400	Oxygen	1	N2411235
Reduction	Quartz	2400	Oxygen & Sulfur	1	N2411300
Reduction	Quartz	2400	CHN	1	N2411291
Reduction	Quartz	2400	CHN	10	N2410154
Scrubber	Pyrex®	2400/ 2410	Oxygen & Nitrogen	1	N2411359

Pre-Packed Tubes

Pre-packed tubes are a time-saving and cost-effective alternative to packing your own tubes.



Description	Est. Runs*	Part No.
Prepacked CHN Oxidation Tube	1000*	N2410695
Prepacked CHN Reduction Tube	150-180*	N2410694
Prepacked CHNS Oxidation/Reduction Tube	70*	N2410693
Prepacked Oxygen Pyrolysis Tube	1000*	N2410696
Prepacked Scrubbing Tube (Argon Sealed)	250*	N2410697
Prepacked CHNS/Oxygen Reduction Furnace	N/A	N2410698

* Estimated runs derived by PerkinElmer under ideal conditions, actual customer runs may vary.

Packing Supplies

Description	Part No.
Silver Gauze Strip, 1.2 x 15 cm (pkg. 1)	N2410145
Platinum Gauze Strip (pkg. 1)	N2411273
Quartz Wool, (50 g)	02401118*
Copper Diffusion Plug	N2411333
Tube Stand Assembly with filling guides includes insert guides for filling combustion and reduction tubes	N2410267

* Only sold in the US due to export restrictions.

Receptacles



Quartz Tube Insert **N2411401**

Description	Qty.	Part No.
Quartz Tube Insert, for all modes: CHN/CHNS/O ₂	1	N2411401
Vial Receptacle, metal, for EA 2410 only	1	N2411335
Vial Receptacle, metal, for EA 2410 only	10	N2410177
Vial Receptacle, Ceramic	1	09904866

EA Accessories

Provetus 6500 Ultra-Microbalance

The new Provetus 6500™ Autobalance is a microprocessor-controlled ultra-microbalance capable of weighing samples in the range of 0.1 µg–1000 mg to a resolution of 0.1 µg with a five-figure display resolution. Provetus offers a wide range of features, including high performance, fully automated operation, automatic calibration, and user convenience. Used in production areas for the calibration of precision micropipettes, weighing precious metals, food stuffs, dispensing modern drugs, and preparing costly instrument standards in the environmental and biotechnology areas where accurate and precise measurements are vital to their results.



Provetus 6500
Ultra-Microbalance
N5340016

It features an easy-to-use keyboard with a graphical OLED display and microcomputer control. Weighing changer has right-or left-hand access and is separate from microcomputer controller for maximum flexibility in any laboratory environment. Pan arrests are standard. Built-in microprocessor functions include Automatic Tare, Automatic Calibration, and Automatic Range Selection. Additional features include storage capacity for up to 6000 sample weights, statistical calculations and weight factoring using multiplicative or additive factors.

Description	Part No.
Provetus 6500 Ultra-Microbalance	N5340016

PE 2400 Series Autosampler

The PE 2400 Series Autosampler automates the introduction of up to 60 samples to the Elemental Analyser. Installation requires a Service Engineer.



PE 2400 Series Autosampler
N2410101

Description	Part No.
PE 2400 Series Autosampler	N2410101
Spare Autosampler Carousel	N2410016
Pawl Accessory, an indexing tool for the Autosampler	N2410018

Column Switching Accessory (CSA)

The Column Switching Accessory allows you to easily switch between CHN/S and Oxygen analysis. It upgrades 2400 Series II systems without built in column switching with this capability.

Description	Part No.
Column Switching Accessory	N2410265

Gas Regulators and Gas Line Assemblies

Carrier Gas Regulator

The Carrier Gas Regulator is a high-purity, two-stage regulator of Helium or Argon gas. It has a brass body, a stainless steel diaphragm, and guarantees constant pressure delivery regardless of variations in cylinder pressure. GCA 580 fitting for connection to cylinder.



Description	Part No.
Carrier Gas Regulator	N2410172

Combustion Gas Regulator

The Combustion Gas Regulator guarantees a constant deliver pressure of Oxygen even when the cylinder pressure varies. This two-stage regulator has a brass body and a stainless steel diaphragm. It comes with a CGA-540 adapter.



Features include:

- Maximum Inlet Pressure: 20,700 KPa.
- Swagelok™ Fitting (1/4 in. NPT to 1/8 in.) for gas tube purging.

Description	Part No.
Combustion Gas Regulator	02400084

Pyrolysis Gas Regulator

The Pyrolysis Gas Regulator delivers high-purity pyrolysis gas (5–8% Hydrogen in Helium) for Oxygen Analysis. It can also be used as a reagent reduction. Included is a CGA 350 fitting and Swagelok brass fittings, 1/4 in. to 1/4 in. and 1/4 in. to 1/8 in.

Description	Part No.
Pyrolysis Gas Regulator	N2410327

Carbon Dioxide Regulator

The Carbon Dioxide Regulator is a dual stage regulator with a metallic diaphragm for high purity gas. It comes with a CO₂ gas warmer, a CGA 320 cylinder, fitting tubes (09903150), and five regulator gaskets (09923121).

Description	Part No.
Carbon Dioxide Regulator, 110 V	N2410502
Carbon Dioxide Regulator, 220 V	N2410503

Pneumatic Gas Regulator

The Pneumatic Gas Regulator is a single-stage regulator with a neoprene diaphragm. It can be used to regulate Nitrogen, Helium, Argon, or air. Included is a CGA 590/580 inlet connector and a Swagelok Fitting, 1/4 in. NPT to 1/4 in. Maximum inlet pressure is 3000 PSI.



Description	Part No.
Pneumatic Gas Regulator	N2410172*

* This accessory can connect to the Gas Filter Dryer (N2410169). For a direct connection to a 1/8 in gas line, order the Swagelok Reducer Fitting (09903471).

Gas Filter Dryer Kit

The Gas Filter Dryer kit removes moisture and particulates from your purge gas. Includes all fittings necessary to easily connect to Pneumatic Gas Regulator. Required, but not included are PTFE tape (09908216) and tubing (N2410147).



Description	Part No.
Gas Filter Dryer	N5370103

Gas Line Assembly Kits

These Gas Line Assembly Kits ensure proper, easy pneumatic connections. Each kit supplies a set of tubes, copper or plastic, and a tubing insert.



Description	Part No.
Copper Gas Line Kit Includes: 2–6ft long Copper Tubing (1/8 in. ID) with 1/8 in. Swagelok fittings on each end	N2410170*
Plastic Gas Line Assembly Includes: 2–1 ft long Tygon Black Tubing (1/8 in. ID), Tubing Insert, and compression-type End Caps	N2410147

Replacement Tube Fittings

A variety of hardware fittings are required to connect the glassware to your PerkinElmer Elemental Analyzer. The nuts, washers, O-Rings, and other fittings listed here are identical to the parts which were shipped with your instrument. Use them as replacement parts to ensure perfect connections.

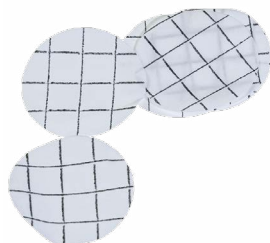

11 mm Filter Disk 02400137

Description	Part No.
1 Filter Disk, 11 mm, (pkg. 12) For use with Crossover Fitting Bracket Assembly (N2410315)	02400137
1 Filter Disk, 25 mm, (pkg. 12) For use with Crossover Fitting Bracket Assembly (N2420214)	N2410237
2 O-Ring, 25 mm Silicone, (pkg. 1) For use with the 2400 Combustion Tube	09902188
2 O-Ring, 25 mm Viton®, (pkg. 1) For use with the 2410 Combustion and Reduction Tube	09902048
3 Glass Tube Washer, 25 mm, (pkg. 1)	N2411118
4 Glass Tube Nut, 25 mm, (pkg. 1)	N2411117
5 25 mm Combustion Tube Ceramic Ring, (pkg. 1)	N2411341
6 O-Ring, 11 mm Viton, (pkg. 12)	02401583
7 Glass Tube Washer, 11 mm, (pkg. 1)	02401042
8 Glass Tube Nut, 11 mm, (pkg. 1)	02401028
9 11 mm Reduction Tube Ceramic Ring, (pkg. 1)	N2411342
10 Crossover Fitting Bracket Assembly For use with 2400 (pkg. 1)	N2410315
10 Crossover Fitting Bracket Assembly For use with 2410 (pkg. 1)	N2420214

Auto-Injector Spares

Description	Part No.
O-Ring, Auto-Injector RAM for use with 2400 (pkg. 1)	09902048
O-Ring, Auto-Injector RAM for use with 2410 (pkg. 1)	09902035
Spring, Auto-Injector RAM for use with the 2400 and 2410 (pkg. 1)	09920404
O-Ring, Sample Drop Valve for use with the 2400 and 2410	09902123

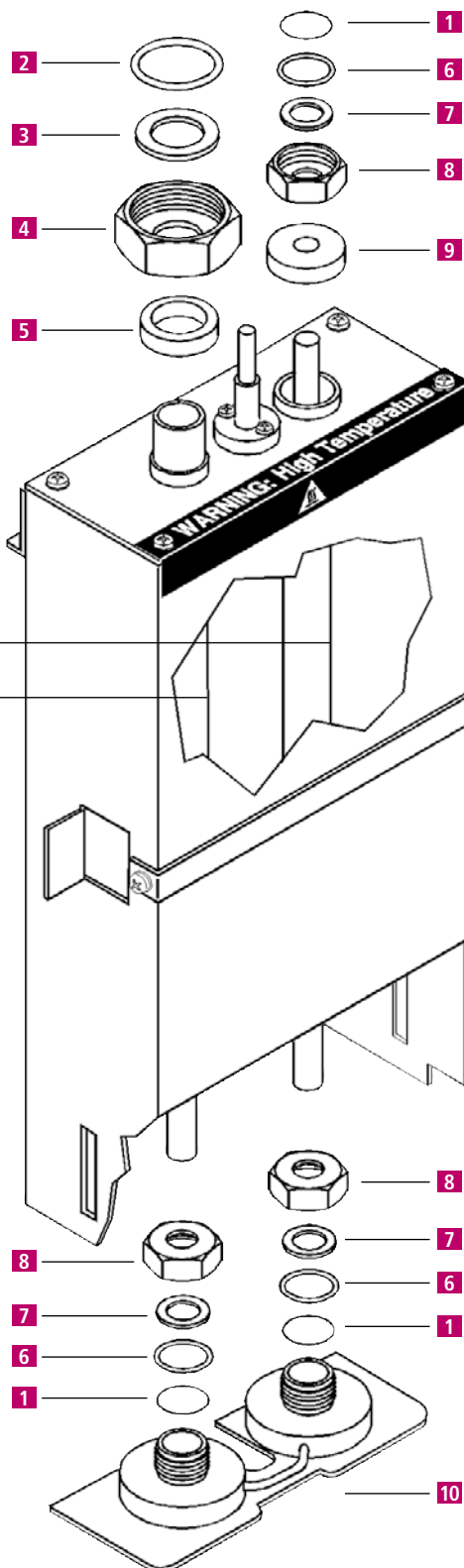

PerkinElmer 2400 CHNS/O Combustion and Reduction Tube Connections

Fittings and Spare Parts

To keep your instrument operating efficiently, you should clean and rebuild valves every year. The parts offered here can all be replaced without the assistance of a service engineer. Instructions for replacing these parts are included in your operator's manual.

Fittings for Scrubber

Description	Part No.
1 Filter Disk, 11 mm, (pkg. 12) For use with bottom end of Scrubber Tube (N2411359)	02400137
2 O-Ring, 11 mm Viton, (pkg. 12)	02401583
3 Glass Tube Washer, 11 mm, (pkg. 1)	02401042
4 Glass Tube Nut, 11 mm, (pkg. 1)	02401028
5 Scrubber Tube For use with 2400 in oxygen analysis mode as an acid-gas scrubber For use with 2410 in nitrogen as a water scrubber	N2411359

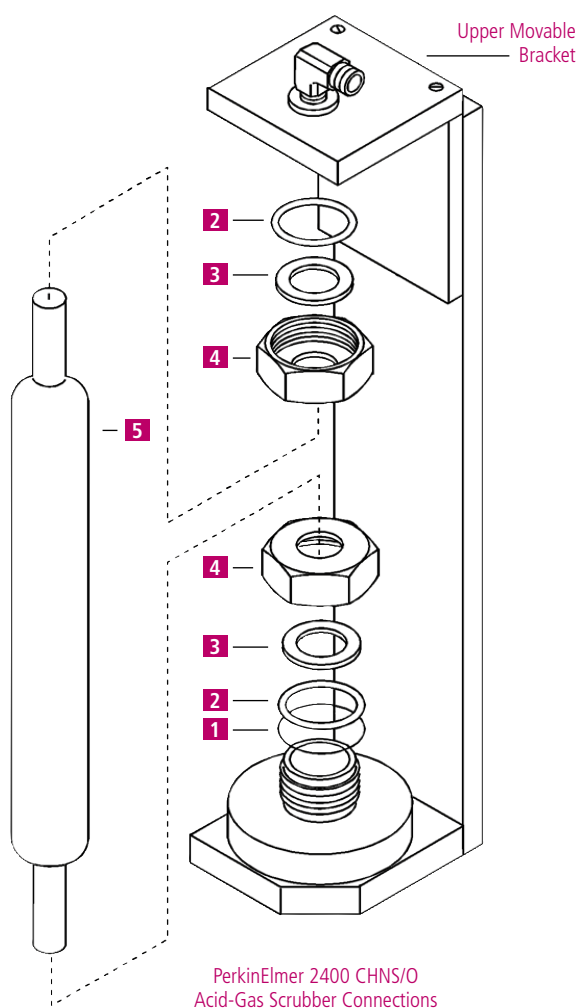

Valves Spare Parts

The valves labeled A, B, D, E, F, G, H, and I are Normally Closed Valves. When rebuilding a Normally Closed Valve, you should replace the Plunger (**1**), Plunger Spring (**2**), and the O-Ring (**3**). The D and E valves in the Effluent Manifold, direct the sample gas into the mixing volume portion of the system. These two valves contain an In-Line Filter Assembly (**09903665**) to filter residue or dirt particles which could affect the valves' efficiency. The 10 µm Solenoid Gas Line filter (**09903673**) inside the filter assembly will require periodic replacement. On the Normally Open C Valve, the Plunger (**4**), Plunger Spring (**5**), O-Ring (**3**), and Adapter Seal (**6**) must be replaced.



Valve Plunger **N2411257**

Description	Part No.
Normally Closed Valve Assembly	N2411087
2 Valve Plunger Spring	02401291
1 Valve Plunger	N2411257
3 Valve O-Ring	02401293
Normally Open Valve Assembly	N2411088
6 Valve O-Ring Adapter	02402089
4 Valve Plunger	N2412088
5 Valve Plunger Spring	N2411088
3 Valve O-Ring	02401293

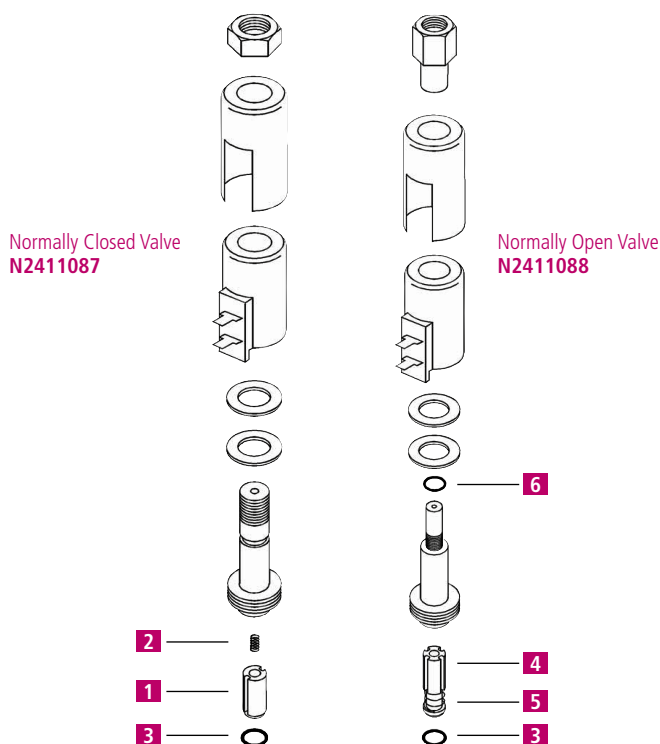

Capsules and Consumables

Tin Capsules

These tin capsules are used for the analysis of nonvolatile solid samples. As they burn, the tins release heat, causing the sample to break down more quickly and completely. These capsules are routinely used to analyze polymers, soils, coal, dry diary products, plant leaves, papers, textiles, calibration standards, and many organic and pharmaceutical products. Light weight capsules produce 40% less ash than standard weight capsules, and provide a corresponding reduction in blank values.



Standard Tin Capsule Kit
N2411255

Description	Dimension	Qty	Part No.
Standard Tin Capsule Kit for solids and viscous, non-volatile liquids	5 mm x 7 mm	96	N2411255
Standard Tin Capsule Kit for larger sample weights of solids with inert material (soil, silica beads) and lower carbon (pkg. 10)	5 mm x 7 mm	960	N2410155
Large Tin Capsule Kit	7 mm x 14 mm	250	N2411362
Tin Capsules Light Weight	5 mm x 8 mm	100	N2411702
Tin Capsules Light Weight	4 mm x 6 mm	100	N2411703

Smooth Wall Tin Capsules

Smooth wall tin capsules with flat bottoms are suitable for liquid samples, and can be sealed with a proprietary sealing tool or mole grips.

Description	Dimension	Qty	Part No.
Smooth Wall Tin Capsule	3 mm x 6 mm	100	N2411708

Tin Pans and Covers

For volatile liquid or solid samples, including viscous materials. Requires, but does not include, Volatile Sample Sealer (02190061).

Description	Qty.	Part No.
Volatile Tin Sample Pans and Covers for volatile, viscous liquids, e.g., Urea Formaldehyde	400	N2410320

Flat Tin Disks

These flat tin disks are used for analyzing 13 mm or 25 mm filters, which are commonly used in air pollution and oceanographic studies. Aluminium disks are good for low level analysis as they can be pre-baked.

Description	Dimension	Qty	Part No.
Flat Tin Disks for particulate material collected on a glass filter		100	N2411363
Flat Tin Disks (pkg. 10)		1000	N2410244
Silver Foil Disks	30 mm	100	N2411706
Aluminium Foil Disks	30 mm	100	N2411707

Silver Capsules

These silver capsules are used for analyzing organic substances for oxygen content. Light weight capsules produce 40% less ash than standard weight capsules, and provide a corresponding reduction in blank values.

Description	Qty.	Part No.
Silver Capsules	96	N2411364
Silver Capsules Light Weight 5 mm x 8 mm	100	N2411704
Silver Capsules Light Weight 4 mm x 6 mm	100	N2411705

Aluminum Capsules

For analyzing volatile liquid samples. Requires, but does not include, Liquid Sample Sealer (B0198093) and Tin Capsules.

Description	Qty.	Part No.
Aluminum Capsules, 4 µL	1,000	02400642
Aluminum Capsules, 30 µL	1,000	00090709

Absorbent Discs

Absorbent discs can be used in conjunction with pressed capsules for non-volatile liquids.

Description	Dimension	Qty	Part No.
Absorbent Discs	3.5 mm	100	N2411709

Sample Sealers

These sample sealers are used with volatile, nonviscous, noncorrosive samples.

Description	Part No.
Liquid Sample Sealer	B0198093
Spare Magazine for Liquid Sample Sealer	B0501078
Volatile Sample Sealer	02190061
Copper Diffusion Plug	N2411333

Tools and Spare Parts

Tools and Accessories

The sample handling tools listed below come standard with Elemental Analysis Accessories and Kits. You can also order these tools separately should they become lost or broken.



Description	Part No.
Micro-Pipette, Disposable, 5µL Qty. 250	N2411710
Micro-Pipette Filler	N2411711
Spatula right handed	N2411712
Spatula left handed	N2411713
Forceps curved point	N2411714
Forceps blunt point	N2411715
96-Well Tray	N2411716
Tongs, for removing crucibles and vial receptacles	N2410133
Micro Hayman Spatula	02401286
Single Quill Brush (pkg. 12)	02401296
Hook Tweezers	09908138
Flat Forceps	09908400
Sample Capsule Pedestal	N2411267
Mixing Chamber O-Ring	09902133
Allen Wrench, Hex Key, right angle, 9/64	09907207

EA Instrument Maintenance

The tools and spare parts listed below are primarily used to maintain PerkinElmer's Elemental Analysis instruments. They are available for purchase should an original item need replacing.

Description	Part No.
Solenoid In-line Filter Assembly	09903665
Solenoid In-line Filter (pkg. 1)	09903673
Replacement 10 Micron Filter for (09903665) Pneumatic Valve	N2411019
25 mm Tube Wrench	N2411144
11 mm Tube Wrench	09907204
Spanner Wrench for the Normally Open and Normally Closed Valves	02401294
Retrieving Wire Receptacle Removal	N2411274

THERMAL ANALYSIS

PerkinElmer offers a wide selection of superior quality products designed to work with your PerkinElmer instruments. Our precision designed products deliver the peace of mind that comes from knowing that you'll get the results you need.

Quick Reference Index Page

DSC Sample Pans

PerkinElmer offers a broad selection of sample pans, covers, and crimpers that are designed to meet just about your DSC analytical needs. You'll find pans made of high-quality materials and designed to handle volatile and non-volatile samples under ambient to high-pressured applications.



TGA Replacement Parts & Standards

The TGA analyzers deliver accurate, reliable, and reproducible measurements. To ensure that these instruments continue to perform optimally, PerkinElmer offers a wide variety of sample pans, hangdown wires, balance weights, and furnace calibration materials.



DMA Accessories

The flexible DMA 8000 has a supporting cast of accessories that broaden its already impressive abilities, including a fluid bath, Liquid Nitrogen Cryo Dewars, and the innovative Material and Mesh Pocket sample holders.



TMA Consumables & Accessories

PerkinElmer not only supplies a full range of probes and tools to support your TMA experiments, they also extend these instruments with cost-effective accessories like the Turbulent Chamber kit and the IC2 refrigeration unit.



EGA Hyphenation

Hyphenation, the process of coupling two or more instruments, delivers results not possible with a single analyzer. PerkinElmer's TL Series harnesses the power of this technique and with the addition of EGA accessories, supports and your EGA experimentation.



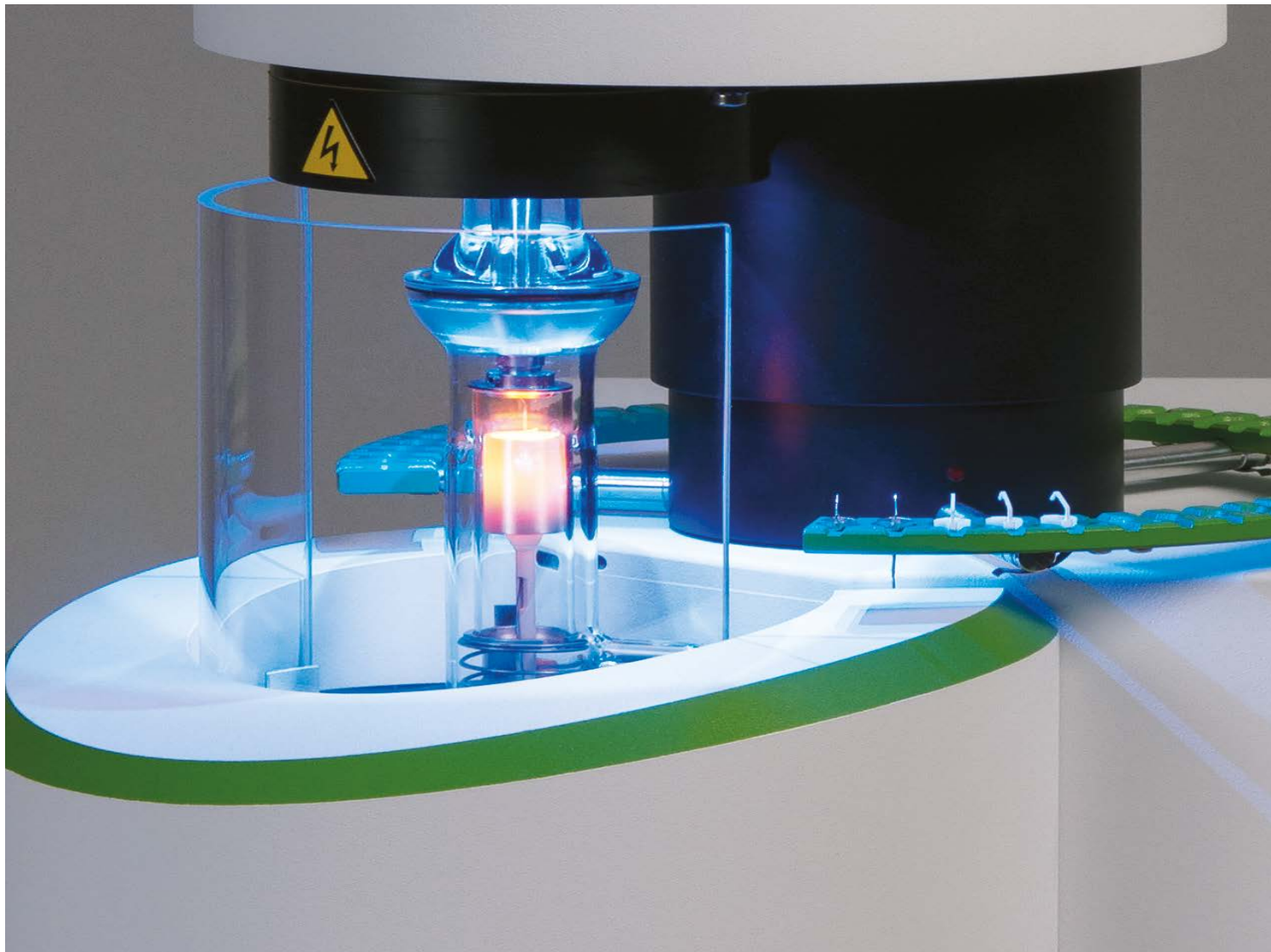

OPEN YOUR EYES TO
A WORLD OF
OPPORTUNITY
IN THERMAL ANALYSIS



DSC/STA/DMA/TGA
Comprehensive Solutions for Thermal Analysis

JCANO
INGENIERÍA DE MÉXICO
Equipo de Laboratorio, Mantenimiento, Capacitación y CRM personalizado

PerkinElmer
For the Better

Thermal Analysis Instruments



DSC 4000

Single-furnace Differential Scanning Calorimeter (DSC) uses the Heat Flux Measurement for studying phase transitions, such as melting, glass transitions, or exothermic decompositions. Extremely accurate measurements.

- Temperature Range: -100–450°C.
- Controlled heating rate: 0.01–100°C/min.
- Low-mass furnace and easy-to-fit lids for fast measurements.
- Integrated mass flow controller for convenient gas control and switching.
- Hardened nickel chromium plate with no exposed thermocouples makes cleaning easy.
- Portable Cooling Device (PCD) enables cost-effective operation while temperature range and robustness prevents furnace oxidation.
- Optional 45-Position Autosampler available.
- Can be upgraded to the DSC 6000.
- 21 CFR Part 11 and EU Annex 11 compliance Software.

Applications:

- Traditional materials characterization research.
- Routine quality assurance and goods-in testing in the polymer and pharmaceutical markets.
- Oxidative Induction Testing (OIT).
- Multi-user, ad-hoc DSC analysis.



DSC 6000

Single-furnaced, temperature-modulated Differential Scanning Calorimeter (DSC) that extends the capabilities of the base model.

- Temperature Range: -100–450°C.
- Controlled heating rate: 0.01–100°C/min.
- The included modulated Temperature DSC (MT_DSC) accessory enables the separation of kinetic events and simplifies the interpretation of data.
- Liquid nitrogen cooling enables the faster cooling rates needed for challenging applications.
- Optional UV Adapter Kit supports photo-calorimetric studies on UV-initiated cures or decompositions.
- Includes a FAST 45-Position autosampler for reliable unattended operation.
- Between-sample cooling times (100–0°C with intracooler accessory) is under 4 minutes, enabling fast sample turn around.
- Standard software includes Pyris™ software, Pyris Player, Isothermal Kinetics, Scanning Kinetics, Specific Heat and Purity packages.
- 21 CFR Part 11 and EU Annex 11 compliance Software.

Applications:

- Advanced materials research.
- Analytical services.
- Multipurpose analysis.



DSC 8000

Double-furnace DSC with enhanced software package, MT-DSC provides precise energy measurements by directly measuring the heat flow between two independent furnaces. The two furnaces are much lower in mass than a single furnace design allowing for a much faster thermal response and faster cool down times.

- Temperature range -170–750°C.
- Controlled heating (0.01–300°C/min) and cooling (0.01–150°C/min) rates.
- Between-sample cooling times (100° to -100°C with CLN2 cooling accessory) less than 80 seconds.
- High-pressure cell option enabling measurement of samples up to 600 psi.
- MT-DSC enables the separation of kinetic and thermal events.
- Remote sampling head enables measurement of hazardous samples.
- Non-oxidating, chemically resistant platinum alloy furnaces. Superior thermal conductivity for fast furnace response.
- Optional UV-Photocalorimeter accessory.
- Automated DSC cover and Semi-automated sample loading accessory for Easy, quick sample loading and unloading.
- Can be upgraded to the DSC 8500.
- Optional 96-Position autosampler provides fast, reliable, unattended operation.
- 21 CFR Part 11 and EU Annex 11 compliance Software.

Applications:

- Isothermal kinetics studies.
- UV curing in polymers – rapid response measures even the fastest cures.
- Process and product improvement.
- Demanding industrial and academic research.

DSC 8500

Double-furnace DSC with HyperDSC technology and an enhanced software package.

- Temperature range -170–750°C.
- Controlled heating (0.01–750°C/min) and cooling (0.01–750°C/min) rates.
- Between-sample cooling times (100°C to -100°C with CLN2 cooling accessory) less than 30 seconds.
- Symmetrical design ensures that instrument response from sample and reference pans is always identical.
- Non-oxidating, chemically resistant platinum alloy furnaces. Superior thermal conductivity for fast furnace response.
- Extremely chemically robust. Can operate with oxygen at temperatures >600°C to allow furnaces to be cleaned by combustion.
- Extremely fast controlled scanning rates (750°C/min) and data readout rates (100 points/second) provide high data integrity.
- In-situ ballistic cooling to 2100°C/min, enabling experiments that mimic real-world processes.
- Optional 96-Position autosampler provides fast, reliable, unattended operation.
- 21 CFR Part 11 and EU Annex 11 compliance Software.

Applications:

- Characterization of pharmaceutical materials.
- Polymorph characterization in pharmaceuticals.
- Process studies in pharmaceuticals to understand how the process affects the amorphous/crystalline content of the product.
- Process simulation in plastics to see the effects the process has on the product.

Thermal Analysis Instruments



TGA 4000

Thermogravimetric analyzer (TGA) used to determine the characteristics of samples such as volatility, moisture content, and oxidation stability. It measures the changes in weight in relation to the change in temperature. Extremely precise and accurate measurements.

- Temperature Range: 15–1000°C.
- Temperature Accuracy: +/- 1°C (From Curie Point Reference).
- Temperature Precision: +/- 0.8°C (Established using Curie Point Reference Material).
- High performance balance and furnace for accuracy and precision.
- Top loading balance for easy sample load and unload.
- Fast cooling for reduced cycle times and improving productivity.
- Integrated mass flow controller extends applications flexibility.
- Optional 45-Position autosampler with sample change over rate of less than 2.5 mins. An optional transparent cover comes standard with the Autosampler.
- Optional IR and MS gas analysis.
- Easy-to-use Pyris software suite.
- 21 CFR Part 11 Compatible.

Applications:

- Decomposition points of explosives.
- The level of inorganic and organic components in materials.
- Absorbed moisture content of materials.
- Determine degradation temperatures of polymers.



TGA 8000

Thermogravimetric analyzer (TGA) has a vertical design with a highly sensitive balance and a quick response furnace. The balance, located above the furnace, is thermally isolated from it. A precision hang-down wire, suspended from the balance, holds a platinum or ceramic sample pan in the furnace.

- High sensitivity ultra-microbalance, has a sensitivity of 0.1 µg and maximum capacity of 1300 mg.
- Low mass (<10 g) furnace produces temperatures with a precision of ±1°C. Its platinum heating element, with its ceramic protective coating, is resistant to inert and oxidative gases.
- Optional AccuPik accessory improves automated measurement of volatile samples.
- Two integral mass-flow controllers provide balance and sample purge. Built-in gas switching from Pyris software makes switching gases easy.
- Optional gas mixing allows the blending of up to three reaction gases with delivery direct to the sample area.
- Designed for hyphenation ensures fast, simple, efficient coupling to FT-IR, GC/MS, MS.
- Effective temperature range from -20–1,200°C and heating rates from 0.1–500°C/min.
- 21 CFR Part 11 and EU Annex 11 compliance Software.

Applications:

- Decomposition and thermal stability studies.
- Component identification and quantification.
- Moisture/solvent evolution and identification.
- Reaction kinetics and modeling.
- Research & Development and QA/QC.



DMA 8000

Dynamic mechanical analyzer (DMA) with built-in electrical heater control system measures changes of rheological behavior under dynamic conditions as a function of temperature, time, frequency, stress, atmosphere, or a combination of these parameters.

- Six geometry modes available covering the full range of sample testing needs.
- Ultra-efficient cooling system with the ability to cool down to -190° (without immersion) uses low-pressure liquid nitrogen vessels for simple, convenient operation.
- Unparalleled flexibility with rotating analysis head and lightweight analytical train.
- Integrated fluid bath option available as either a 1L dewar or a 50L dewar.
- Allows humidity level to be varied during the run.
- Heated transfer line to avoid condensation.
- DMA response plotted against humidity.
- Optional Quartz furnace window allows for sample and clamp viewing throughout the experiment without interrupting experimental conditions.
- 21 CFR Part 11 and EU Annex 11 compliance software.

Applications:

- Moisture-induced phase transitions.
- Moisture-sensitive materials like paper, natural fibers, and food products.
- Swelling, shrinking, and stiffness changes as humidity changes.
- Plasticizing and T_g effects as seen in nylon and polyurethanes.



STA 6000/8000

Simultaneous thermal analyzers (STA) with easy-to-load vertical sample systems provides real-time measurement and analysis of sample weight change and heat flow.

- Simultaneously acquires both TGA and DTA/DSC measurements, enabling fast, enhanced results interpretation from a single sample run.
- Extended temperature analysis up to 1600°C .
- Unique split-carousel design.
- Balance below furnace for optimum isolation from contamination.
- STA 6000 is equipped with SaTurnA sensor technology and optional fully-integrated autosampler.
- Automated gas control and switching.
- Integrated mass flow controllers.
- 21 CFR Part 11 and EU Annex 11 compliance Software.

Applications:

- Compositional analysis – quantitative content analysis.
- Decomposition temperatures.
- Engine oil volatility measurements (TGA Noack test).
- Flammability studies.
- Measurement of volatiles (e.g. water, oil).
- Oxidative stabilities.
- Catalyst and coking studies.
- Hyphenation to identify outgassing products.

DSC Accessories

UV Adapter Kits

The UV Adapter with a source contain the parts necessary to perform photo-calorimetric studies on DSC instruments. UV-Adapter kits without a source attach a pair of light guides to the instrument. These guides still allow both legs to be individually adjusted.

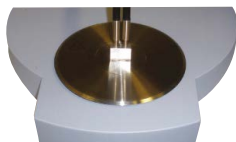

UV-Adapter Kit with Source
N5370449

Description	DSC Model	Part No.
UV Adapter Kit without Source	4000/6000	N5370448
UV Adapter Kit with Source	4000/6000	N5370449
UV Adapter Kit without Source	8000/8500	N5340400
UV Adapter Kit with Source	8000/8500	N5340401

Autosamplers

PerkinElmer offers 45- and 96-Position autosamplers providing reliable, unattended sample introduction to the DSC instruments. Required, but not included, is installation by a PerkinElmer Service Engineer.



AS 8000 AutoSampler
N5200002

Description	DSC Model	Part No.
AS 8000, 45-Position	4000/6000	N5200002*
Autosampler, 96-Position	8000/8500	N5340021

* Replacement part for the AS 6000.

Provectus 6500 Autobalance

The Provectus 6500™ Autobalance is a microprocessor-controlled ultra-microbalance capable of weighing samples in the range of 0–1000 mg to a resolution of 0.1 µg with a five-figure display resolution.



Provectus 6500 Autobalance
N5340016

Description	DSC Model	Part No.
Provectus 6500 Autobalance	4000/6000/ 8000/8500	N5340016

PYRIS Series USB Multiport Converters

The PYRIS Series USB Multiport Converter cables allow multiple instruments with Serial Communications cables (RS232) to be connected to the DSC 4000/6000 analyzers via their USB port.

Description	Part No.
PYRIS Series USB Multiport, 4 ports	09402020
PYRIS Series USB Multiport, 8 ports	09402019

Flow-Through Cover Upgrade Kit

The Flow-Through Cover Upgrade Kit is designed to significantly reduce the build-up of decomposition products for instruments without Autosamplers. The cover has an exit port with a non-porous foam gasket that allows the sample and system purge gases to exit the unit via PVC tubing that has been routed to a ventilation device. This cover replaces the DSC standard sample enclosure cover.

Description	DSC Model	Part No.
Flow-Through Cover Upgrade Kit	8000/8500	N5340287

Thermal Cooling Accessories

These accessories provide thermostatic control as recirculating baths of coolant, sealed refrigeration, units or liquid N₂ cooling systems.

Chiller Units

The PolyScience Chiller is a re-circulating fluid bath of coolant pumped through lines to a recirculation head bolted to the DSC. It can be set at various temperatures from -20°C to above ambient. The cooling medium must be adjusted to achieve the desired temperature range. The top-of-the-line Circulating Chiller provides durable and reliable temperature control (accuracy of 0.01°C) and can store up to ten programs with up to fifty steps each.



PolyScience Chiller N5370220

Description	DSC Model	Part No.
PolyScience Chiller, 120 V	4000/6000	N5370220
PolyScience Chiller, 220 V	4000/6000	N5370221
Circulating Chiller, 120 V	8000/8500	N5340037*
Circulating Chiller, 230 V	8000/8500	N5340038*

* Requires, but does not include DSC8000/8500 LN₂/Chiller Bolt kit (N5340027) and DSC8000/8500 Cooling Water Kit (N5340195).

Intracoolers

The Intracooler Series cool the sample holder enclosure block of the DSC instruments. They are closed-loop circulating heat exchangers with a compact mechanical refrigeration unit. They are an excellent economical option for laboratories requiring low temperatures or fast cooling rates, but with limited access to liquid N₂. The Intracooler II series has a dual stage heat exchanger with a temperature range that encompasses most DSC applications work.



Intracooler SP **N5374098**

Description	DSC Model	Part No.
Intracooler SP, 120 V, -30°C in DSC	4000/6000	N5374098
Intracooler SP, 220 V -30°C in DSC	4000/6000	N5374099
Intracooler II Viper, 100 V, -60°C in DSC	8000/8500	N5340039
Intracooler II Viper, 120 V, -65°C in DSC	8000/8500	N5340040
Intracooler II Viper, 230 V, -65°C in DSC	8000/8500	N5340041

The Liquid Nitrogen Cooling Systems

Liquid Nitrogen Cooling Systems automatically cool the Autosampler environments for DSC instruments allowing analysts to do other tasks. Compatible with the DSC 6000 (with Autosampler) and DSC 8000 (with and without Autosamplers).

Description	DSC Model	Part No.
Cryofill Liquid Nitrogen Dewar, 50 L, Operating range of -170–300°C (under He purge)	6000 w/ Autosampler DSC 8000	N5373009
LN2 System, 110–240V, Operating range of -170–750°C.	8000/8500	N5340046*

* He recommended as purge gas for temperatures below -130°C.

Portable Cooling Device

The Portable Cooling Device adds the full power of Liquid Nitrogen cooling to the DSC 4000/6000 instruments. Designed for occasional use, this device extends the minimum temperature an analyzer can achieve when combined with the PolyScience Chiller or Intracooler Systems to -140°C. Using this device requires that any existing circulator be removed.

Description	Part No.
Portable Cooling Device	N5202068

Mini Dry Box

The Mini Dry Box accessory provides a protective cover for the DSC 4000/6000 instruments. It is recommended for lab work done in humid environments.

Description	Part No.
Mini Dry Box	N5202070

DSC Upgrade Kits

DSC System Upgrade Kits

These kits include the Firmware and an Advanced USB software key necessary to upgrade a DSC instrument to the specified level. A label identifying the analyzer's upgraded level is also provided.

Description	Part No.
Upgrades the DSC 4000 without Autosampler to DSC 6000 without Autosampler	N5202104
Upgrades the DSC 4000 without Autosampler to DSC 6000 with an Autosampler	N5202105*
Upgrades the DSC 4000 with Autosampler to DSC 6000 with Autosampler	N5202106
Upgrades the DSC 8000 without Autosampler to DSC 8500 without Autosampler	N5340509**

* Kit includes the AS 8000 (**N5200002**). Requires, but does not include, installation by a PerkinElmer Service Engineer.

** Requires installation by a PerkinElmer Service Engineer to upgrade firmware and setup testing.

DSC Autosampler Upgrade Kits

These kits update DSC analyzers with the AS 8000 45-Position Autosampler (**N5200002**). Also included is Firmware and an Advanced USB Software key. These upgrades require, but do not include, installation by a PerkinElmer System Engineer.

Description	Part No.
Upgrade Kit – DSC 4000 Autosampler Upgrades the DSC 4000 without Autosampler to a DSC 4000 with an Autosampler	N5202100
Upgrade Kit – DSC 6000 Autosampler Upgrades the DSC 6000 without Autosampler to a DSC 6000 with an Autosampler	N5202101
Upgrade Kit – DSC 8000/8500 Autosampler Upgrades the DSC 8000/8500 without Autosampler to a DSC 8000/8500 with an Autosampler Kit includes the Viper-tested Autosampler (N5340047) and the Dust Cover Assembly (N5340111)	N5340021

Sample Pans, Covers, and Crimpers

PerkinElmer offers a wide range of precision designed and manufactured sample pans to cover virtually any thermal analysis application. With varying materials as well as specialty products, you'll be sure to find the perfect product to handle any kind of sample for all possible measurements. Our superior quality sample pans and covers are routinely used for applications such as polymer melting, crystallization, glass transitions of polymers, thermoplastics and thermosets. Ambient sample pans are available in aluminum, copper, or gold, and they have the option for crimping.



Open/Crimped Pans

Open/Crimped pans have an operating range of -170–600°C, an ambient pressure maximum threshold, and come in packages of 400. All DSC instruments come standard with Sample Pan Kit (**02190041**). The below pan sets can use either the Standard Crimper (**02190048**) or the Universal Crimper (**B0139005**) with the Aluminum Pans and Covers Insert (**B0508921**).

Description	Qty.	Part No.
Aluminum Sample Pan Kit	100	N5370123
Standard Aluminum Pans and Covers	400	02190041
Supra Clean Pans and Lids, Aluminum	100	02192005

High Pressure Pans and Covers

These High Pressure Pans and Covers contain a sample in a sealed environment throughout an experiment. This ensures that the heat generated from vaporization or a volatile reaction does not interfere with the analyzer's measurements. These pans are compatible with DSC 6/7/4000/6000/8000/8500 as well as the Diamond DSC, Pyris 1 DSC, Pyris 6 DSC, and Jade DSC instruments. Maximum Pressure Range: 24–150 Bars.

Description	Operating Range	Vol. (μL)	Max Pressure	Qty.	Crimper (Sealer)	Part No.
Stainless Steel Pans, Covers and O-Rings	-40–300°C	60	24 bar	1	B0139005 with B0505340 -or- 09908467 with 03191047	03190218
Stainless Steel Pans, Covers and O-Rings	-40–300°C	60	24 bar	1,000	B0139005 with B0505340 -or- 09908467 with 03191047	03190029
Stainless Steel Pans, Covers, and Disposable Seals	-170° to 400°C	30	150 Bars	5	B0182864	B0182901
Reusable Gold-Plated Pans, Covers, and Disposable Seals	-170° to 400°C	30	150 Bars	5	B0182864	B0182902*
Reusable Titanium Pans, Covers, and Seals	-170°C to 400°C	30	150 Bars	5	B0182864	B0182903*

* Disposable seals come pkg. 20. Replacement gold-plated seals available (**B0182905**). Replacement titanium seals available (**B0185054**). Recommended for O.I.T tests.

Vented/Pierced Pans

Vented/Pierced Pans have an operating range of -170–600°C and come in packages of 400. Most use the Universal Crimper (**B0139005**).

Description	Qty.	Part No.
Aluminum Pans and Covers, 0.05 pierced hole, volatile	20	N5190788*
Aluminum Pans, vented	30	B0143018
Aluminum Pans, vented	50	B0143019
Aluminum Covers, 0.05 pierced hole		B7001014

* Used for boiling point, heat of vaporization, and sublimation studies, these Vented Aluminum Pans and Covers come in packages of 100 and are used with the Volatile Sample Sealer (**02190061**) or the Universal Crimper Press (**B0139005**) with the Insert for Volatile Sample Pans (**B0144637**).

Hermetically Sealed/Volatile Pans

Hermetically-Sealed/Volatile Pans are made of Aluminum, have an operating range of -170–600°C and a maximum pressure threshold of one to three bars. Most of the below pans and covers use the Universal Crimper (**B0139005**). These pans and covers are not recommended for use outside of their operating range. They come in packages of 400.

Description	Vol (μL)	Max. Pressure	Part No.
Pans and Covers	10	3 Bars	B0169319
Pans and Covers	30	3 Bars	B0169320
Pans and Covers	50	3 Bars	B0169321
Pans and Covers, volatile	20	2 Bars	02190062*
Pans, only	10	1 Bar	B0143015
Pans, only	30	1 Bar	B0143016
Pans, only	50	1 Bar	B0143017
Covers, solid		1 Bar	B0143003
Covers, solid		3 Bars	B0143004

* The Volatile Pans and Covers can use either the Standard Crimper (**02190048**) or the Universal Crimper (**B0139005**) with the Aluminum Pans and Covers Insert (**B0508921**).



Stainless Steel Pans with O-Rings

Specialty Pans and Covers

PerkinElmer supplies Specialty Pans and Covers for applications that require high temperatures or large sample volumes. With a maximum pressure threshold of ambient, most of these pans do not require a crimper.

Description	Operating Range	Vol. (µL)	Qty.	Part No.
Aluminum Pans with Quartz Covers	-170–600°C	12.5	100	B0198030
Aluminum Pans with Quartz Covers for Photo-calorimetric Analysis	-170–600°C	12.5	100	B0196858
Window Quartz Cover			10	B0181091
Aluminum Pans and Covers	-170–730°C	40	6	N5190180
Copper Sample Pans and Covers	-170–730°C	40	200	03190026*
Graphite Sample Pans and Covers	-170–600°C	40	4	03190025
Gold Sample Pans and Covers	-170–730°C	40	10	02190042
HyperDSC® Pans	-170–600°C	40	100	N5203115
Aluminum Pans and Covers – hand sealable	-170–600°C	1		L90004787
Aluminum Pans and Covers – 6.7 mm x 2.7 mm	-170–600°C	1		L90004788

* The Copper Pans and Covers use the Standard Crimper (**02190048**) and are recommended for O.I.T tests.

Furnace Covers

PerkinElmer supplies Furnace Covers which are vented inserts placed in between the DSC furnace and the sample pan.

Description	Qty./ Pkg.	Model	Part No.
Platinum, vented with 2 holes	2	8000/8500	04190299
Platinum, vented with 2 holes	6	8000/8500	03190031
Autosampler Furnace Covers	1	8000/8500	B0139122
Large Autosampler Furnace Covers for Tall Pans	2	8000/8500	B0182981
Lower Furnace Lid Holder	1	4000/6000	N5203208*
Lower Furnace Sampler Side Lid	1	4000/6000	N5203203*
Lower Furnace Reference Side Lid	1	4000/6000	N5203209*
Upper Furnace Lid Holder	1	4000/6000	N5203204*
Upper Furnace Lid	1	4000/6000	N5203205*
Lower Furnace Lid	1	4000/6000	N5202002**
Upper Lid Measure Cell	1	4000/6000	N5202058**

* For DSC units with an Autosampler

** For DSC units without an Autosampler

Standard Sample Pan Crimper Press

Used to crimp covers on standard DSC pans of aluminum, gold and copper. The design incorporates a replaceable crimper head.

Standard Sample Pan Crimper Press **02190048**



Description	Part No.
Standard Sample Pan Crimper Press	02190048
Replacement Crimper Head	02191171

Universal Crimper Press

The Universal Crimper Press provides high quality pan sealing for most types of pans. This is achieved simply by using the appropriate sealing insert. Includes the sample pan suction tool and inserts to seal 10, 30 and 50 µL sample pans.



Universal Crimper Press (for robotic pans) **B0139005**



Sample Holder Cover Reforming Tool **03190030**

Description	Part No.
Universal Crimper Press (for Robotic Pans)	B0139005
Sample Holder Cover Reforming Tool	03190030
Insert for Volatile Sample Pans	B0144637*
Insert for Stainless Steel Pans	B0505340*
Insert for Standard Aluminum Pans	B0508921*
Insert for Hermetically-Sealed Pans	B0139033*
Upper Replacement Die for Universal Crimper Press	B0139005

* Not included with the Universal Crimper Press.

DSC Sample Handling Accessories

High Pressure Capsule Sealing Tool

The High Pressure Capsule Sealing Tool is fast and precise. It employs a built-in torque clutch which guarantees that all capsules are closed with the same torque. For use with Stainless Steel Pans, Covers, and Seals (**B0182901**), Reusable Gold-Plated Pans, Covers, and Seals (**B0182902**) and Reusable Titanium Pans, Covers, and Seals (**B0182903**).



Description	Part No.
High Pressure Capsule Sealing Tool	B0182864

Quick Press

The Quick Press is a convenient device for sealing stainless steel pans, covers and O-Rings (**03190218** and **03190029**). It requires but does not include spacer die (**03191047**).



Description	Part No.
Quick Press	09908467
Quick Press Spacer Die	03191047

Volatile Sample Pan Insert Kit

The Volatile Sample Pan Insert Kit contains an Upper Die, Guide Ring, and Lower Sample Pan Holder Die used for the following DSC 8000/8500 sampling accessories: the Perforated Volatile Pan Kit (**N5190788**), Gold Volatile Pans and Covers (**02190080**), and the Aluminum Volatile Pans and Covers (**02190062**).

Description	Part No.
Volatile Sample Pan Insert Kit	B0144637

Capsule Closure Tool

The Capsule Closure Tool is an insert for sealing large volume Stainless Steel sample pans and covers.

Description	Part No.
Capsule Closure Tool	B0505340

Lower Sample Pan Holder Die Kit

The Lower Sample Pan Holder Die Kit provides the tools you need to seal standard Aluminum sample pans. This kit comes fully assembled and ready to use.

Description	Part No.
Lower Sample Pan Holder Die Kit	B0508921

Specific Heat Kit

Includes four sapphire disks manufactured to two separate diameters and thicknesses. Also includes a calibration chart giving the specific heat of aluminum oxide in the form of synthetic sapphire.

Description	Part No.
Specific Heat Kit	02190136

Volatile Sample Sealer

The Volatile Sample Sealer is designed to seal aluminum pans and covers (**02190062**) and gold pans and covers (**02190080**). This accessory includes a replacement upper and lower die for the sealer.



Volatile Sample Sealer
02190061

Description	Part No.
Volatile Sample Sealer	02190061
Replacement Lower Die	02191295
Replacement Upper Die	02191296

Large Stainless Steel Capsule Kit

Used for sealing large volume stainless steel pans, this kit comes with a Quick Press (**09908467**), a Quick Press Spacer Die (**03191047**), a Guard Ring Insert (**03190236**), and twenty sealing inserts (**03190218**).



Large Stainless Steel Capsule Kit
03190021

Description	Part No.
Large Stainless Steel Capsule Kit	03190021

Sample Holder Supplies

Sample Holder Cover Reforming Tool

DSC performance is enhanced with sample holder covers that are formed properly and not degraded by extended usage. This tool allows the analyst to reform the platinum covers to their original dimensions.



Sample Holder Cover Reforming Tool

Description	Part No.
Sample Holder Cover Reforming Tool	03190030

Diamond DSC Loading Tool

Allows for easy insertion and removal of sample or reference pans and covers platinum lids.



Description	Part No.
Diamond DSC Loading Tool	N5361180

Platinum Sample Holder Covers

Each cover has two vent holes and is used for the Diamond DSC, Pyris 1 DSC, DSC 7, DSC 8000 and DSC 8500 sample holders.

Vented Platinum Sample Holder Cover



Hook Forceps

Description	Qty.	Part No.
Vented	2	04190299
Vented	6	03190031
DSC 8000 Furnace Covers, (2 required)	1	B0139122*
Large Furnace Covers	2	B0182981

* For use with the DSC 8000 with Autosampler.

Forceps

PerkinElmer provides a series of hardened stainless steel forceps, reliably designed to perform a range of precise sampling handling jobs. Non-magnetic.



Hooked Forceps
09908138

Description	Part No.
Flat Round Tips, Non-Magnetic, Non-Serrated	09908400
Flat Pointed Tips	N5361078
Hook, Non-Magnetic, Non-Serrated	09908138

Sample Pan Manipulators

Sample Pan Manipulators are specially designed to simplify picking up and positioning sample pans and covers. Their use is essential to preventing sample contamination.



Special Sample Pan Manipulator
B0142512

Description	Part No.
Special Sample Pan Manipulator (Suction Device)	B0142512
Standard Sample Pan Manipulator (Aspirator)	B0143263
Replacement Rubber Tip	N5376097

DSC Calibration Reference Standards



PerkinElmer reference standards are 99.999% pure. DSC requires elements of this purity so that the instrument can be accurately calibrated. These standards calibrate all of PerkinElmer's DSC instruments.

Reference Material	Transition Point	Part No.
Indium	156.60°C	03190033
Tin	231.88°C	03190034
Lead	327.47°C	03190035
Pre-Crimped and Weighted Zinc	419.47°C	03190036
Zinc Bulk		N5340229
Encapsulated Kit		02190045*
Encapsulated Kit		N5190762**
Pre-Crimped and Weighted NIST Indium Standard		N5340800

* Includes a large and small indium, tin and lead.

** Includes indium and zinc for DSC 4000, DSC 6000, DSC 8000, DSC 8500, DSC 7, Pyris 1 DSC, DSC 6, Pyris 6 DSC, Jade DSC and Diamond DSC.

TGA 4000 Accessories and Kits

PolyScience Chiller

The Chiller provides dependable temperature control for the TGA 4000/8000 instruments. When combined with the Sub-Ambient Cooling Kit (**N5370553**), the Chiller enables the TGA unit to operate under sub-ambient to elevated temperatures (-5 – 200°C). It also supports faster furnace cool down at the end of experiments using raised temperatures. Reservoir capacity of 7 liters.

Below are the maximum low temperatures the Chiller achieves for common chiller fluids.

Distilled H₂O: 10°C

Ethylene Glycol (30%/H₂O 70%): 0°C

Ethylene Glycol (50%/H₂O 50%): -20°C



PolyScience Chiller
N5370220

Description	Part No.
PolyScience Chiller, 120 V	N5370220
PolyScience Chiller, 220 V	N5370221

TGA 4000 Autosampler Upgrade Kit

Enables the Upgrade of TGA 4000 without an Autosampler, it includes the AS 8000 45-Position Autosampler and all the necessary connections. Installation not included.

Description	Part No.
TGA 4000 Autosampler Upgrade Kit	N5202102

Optional TGA Accessories

Description	Part No.
USB 4 Port Converter for RS232/NT Connects up to 4 additional instruments to one PC	09402020
USB 8 Port Converter for RS232/NT Connects up to 8 additional instruments to one PC	09402019
Mini Dry Box for Non Autosampler Units	N5202070
TGA 4000 Ceramic Sample Pan Kit, 45 pans	N5200045*
TGA 4000 Ceramic Sample Pan Kit, 3 pans	N5200040*

* The TGA 4000, STA 6000, and STA 8000 share many of the same sample pans and furnace accessories. Please see STA Sample Pan Kits and STA Furnace Spares and Tools for more options.

TGA 8000 Accessories and Kits

Gas Mixing Device (GMD) 8000

This optional accessory allows for the mixing of up to three gases, delivering a custom gas environment to your sample. The GMD 8000 has 3 gas inputs, each with its own mass flow controller (MFC). Gas mixing is customized via a PC-based software program included with the GMD 8000.

The customized gas mixture exits from a single outlet and is delivered to the sample through the TGA 8000 reactive gas line.



Description	Part No.
Gas Mixing Device (GMD) 8000	N5320014

TGA 8000 Spares Kit

PerkinElmer ships the TGA 8000 Spares Kit with the instrument. This kit is also available as a source of replacement parts. The kit includes one 100.0 mg ISO 17025 weight (**09200501**), straight forceps (**09908400**), a Platinum Pan kit (**N5320102**), a Ceramic Pan kit (**N5320103**), three O-Rings (**N5320115**, **N5320116**, **N5320117**), a right-angle hex wrench (**N5320118**), a Quartz Furnace Tube Insert (**N5320119**), three Tare weights (**N5320128**, **N5320129**, **N5320130**), Aluminum Oxide powder (**N5320133**), a Quartz Hangdown Wire kit (**N5320140**), the TGA Calibration Standards kit (**N5320201**), the Curie Point Magnet Assembly (**N5370466**), and the Hangdown Wire Alignment Tool (**N5376622**).

Description	Part No.
TGA 8000 Spares Kit	N5320026

Hangdown Ribbon Replacement Kit

The TGA 8000 balance mechanism is designed with replaceable platinum hangdown ribbons, should either the hangdown wire ribbon or the hangdown tare weight ribbon break. This kit includes a Platinum Ribbon Insertion Tool (**N5376741**), Rubber Cement (**09923480**), a Rubber Cement Application Tool (**N5376742**), and two ultrathin Platinum Hangdown Ribbons (**N5370342**).

Description	Part No.
Hangdown Ribbon Replacement Kit	N5370478

Air Dryer Kit

The Air Dryer Kit is an optional accessory that is used to remove moisture, carbon dioxide, and other impurities from your purge gas or any other gas used with the instrument.

Air Dryer Kit
N5370103



Description	Part No.
Air Dryer Kit	N5370103

Regulator Install Kit

The Regulator Install Kit makes it possible to set up a single source gas delivery system (instead of using two gas cylinders, one source and one purge gas) by installing a series of gauges off the regulator on the source gas. This kit contains One Regulator (**09923423**), one polyethylene plug pipe (**09920230**), and a nipple fitting (**09920220**).



Helium/Nitrogen
Regulator 02400085

Description	Part No.
Regulator Install Kit	N5190462
Oxygen Regulator, optional	02400084
Helium/Nitrogen Regulator, optional	02400085

Gas In-Line Filter Trap

The Gas In-Line Filter Trap removes moisture, oil, and dust from supply gases. The Trap has 400 cc total volume of molecular sieve 5A and an indicator in a clear acrylic tube. Maximum pressure is 100 psi (6.9 bar). Dimensions are 6 x 43 cm including fittings, weight is 1.0 kg. The Trap's indicating Drierite® changes color at low relative humidity to let you know the packing must be changed using the Gas In-Line Filter Trap Refill Kit.



Gas In-Line Filter Trap
N9301178

Description	Part No.
Gas In-Line Filter Trap	N9301178
Gas In-Line Filter Trap Refill Kit	N9301176

The AccuPik Accessory Kit

The AccuPik Accessory works with TGA 8000 and Autosampler units. Attached to the underside of the Balance mounting plate, the AccuPik pierces a crimped sample pan just before the pan enters the furnace, protecting sample against evaporation and volatilization. This accessory includes the puncture device and three replacement needles.



AccuPik Accessory Kit
N5320016

Description	Part No.
AccuPik Accessory Kit	N5320016*
AccuPik Replacement Needle Kit	N5370554
AccuPik Aluminum Pans and Covers	N5370550

* Requires, but does not include, AccuPik Aluminum pans and covers (N5370550), and AccuPik Sample Pan Sealer (N5370435).

AccuPik Sample Pan Sealer Accessory

The AccuPik Sample Pan Sealer Accessory is used to crimp covers onto the AccuPik aluminum sample pans. Replacement parts for this accessory are available.



AccuPik Sample Pan
Sealer N5370435

Description	Part No.
AccuPik Sample Pan Sealer	N5370435
TGA AccuPik Sealer Upper Die, Replacement Part	N5376775
TGA AccuPik Sealer Lower Die, Replacement Part	N5376776

Sub-Ambient Cooling Accessory Kit

The Sub-Ambient Cooling Accessory Kit is a double-walled glassware through which cooling water or antifreeze flows, extending the TGA 8000 maximum low temperature to -20°C. For sub-ambient operation, use with the PolyScience Chiller (N5370220 or 5370221). Included in this kit are ten feet of Tygon tubing (02506518), four hose clamps (09903004), one roll of Teflon tape (09908739), two Quick Connect Stems (09920073), six nylon tie wraps (09940294), and one glass tube (N5370333).



Sub-Ambient Cooling Kit
N5370553

Description	Part No.
Sub-Ambient Cooling Kit	N5370553

TGA 8000 Sample Pans, Covers, and Liners

PerkinElmer's sample pans and covers, made from high-quality aluminum, ceramic, or platinum, are designed to hold a variety of substances, both volatile and non-volatile, and to withstand temperatures ranging from sub-ambient to over 1000°C. PerkinElmer also offers both stainless steel and platinum sample pan liners.



Platinum Sample Pan **N5320102**



Ceramic Sample Pan **N5370464**

Description	Size	Part No.
Platinum Sample Pan Kit	2	N5320102
Platinum Sample Pan Kit	5	N5370562
Platinum Sample Pan Kit	25	N5370195
Ceramic Sample Pan Kit	5	N5320103
Ceramic Sample Pan Kit	10	N5370464
Aluminum Vapor Pressure Pan Kits Covers have a 50 micron diameter hole in the center	100	N5190788
AccuPik Aluminum TGA Pans and Covers Kit	400	N5370550
Platinum Sample Pan Liners	400	N5370551
Stainless Steel Liners for Ceramic Pans	400	N5370492

Hangdown Wire Kits and Alignment Tool

Hangdown wires from these kits suspend down from the TGA 8000 Furnace Balance Mechanism, catch a sample pan's handle, and lift it from the TGA 8000 Autosampler and into the furnace. They come in a variety of, materials and kit sizes.



Hangdown Wire Alignment Tool **N5376622**

Description	Qty	Part No.
Nichrome, straight wire, 0.01 mm OD	4	N5100515
Nichrome, hanger wire, 0.01 mm OD	1	N5320131
Quartz, hanger wire, 0.5 mm OD	1	N5320140
Platinum, hanger wire, 0.2 mm OD	5	N5190276
Hangdown Wire Alignment Tool. Once attached to the Hangdown Wire Tube, this U-shaped tool holds the alignment of the hangdown wire steady while a sample pan is placed on it	1	N5376622

Sample Handling Tools

PerkinElmer also offers replacements for the most frequently used sample-handling parts and tools.



Autosampler Sample Tray **N5321003**

Description	Part No.
Autosampler Sample Tray Spare tray, 48-Position removable sample tray for the TGA 8000 Autosampler	N5321003
Hooked Forceps (Non-Magnetic)	09908138
Straight Forceps (Non-Magnetic)	09908400
Micro Spatula	02401286
Brush (pkg. 12)	02401296

TGA Furnace Spares and Accessories

PerkinElmer provides the replacement parts and kits you need to keep the TGA 8000 furnace functioning optimally.

Description	Part No.
Furnace and Thermocouple Replacement Kit, includes Furnace Replacement Assembly (N5321004) and a pre-installed Thermocouple Assembly (N5320150)	N5320122
Furnace Replacement Assembly	N5321004
Thermocouple Assembly	N5320150
Furnace Tube	N5370459
Platinum Furnace Shield	03191628
Spring for TGA Furnace Tube	N5376521
Quartz Furnace Tube Insert	N5320119
Plate for TGA Furnace Tube	N5376522
Magnet, Curie Point Temperature Calibration	N5370466
Static Discharge Kit for use where heavy static condition is expected. Includes Conductive Furnace Tube (N5370472), O-Ring (N5191555), and Silicon grease (09908777)	N5370185

Replacement Parts for TGA Instruments

To keep your TGA analyzers running like new, PerkinElmer provides these general purpose fittings, gas lines, coolant lines, and tubes as replacement parts.

Description	Part No.
Restrictor "A" Type	01541496
Restrictor "H" Type	01541498
Male Connector – 1/4 in. NPT 1/8 in. Swagelok Tube	09903087
Union Reducing – 1/4 in. Swagelok 1/8 in. Tube	09903117
Male Connector – 1/4 in. Swagelok 1/8 in. Tube	09903150
Female Connector – 1/4 in. NPT 1/4 in. Swagelok Tube	09903196
Female Connector – 1/4 in. NPT 1/8 in. Swagelok Tube	09903906
Valve Needle – 1/4 in. Male NPT 1/4 in. Male NPT	09903482
Barb Fitting – 3/8 in. Male NPT 1/4 in. ID Tube	09920026
Round Tygon Tubing R3603 0.25 ID – 10 Feet	02506518
Black Round Tygon Tubing 0.125 ID – 20 Feet	02506515
Clear Tygon Tube – R3603 0.375 in. OD – 0.250 in. ID	02506518
Tubing Insert for use with Black Tygon Tube (02506515)	09903094

Calibration Reference Standards

These Calibration Reference Standards ensure accurate thermogravimetric measurements for all of PerkinElmer's TGA instruments. Magnetic Calibration Reference Standards are available as a kit as well as individually. PerkinElmer recommends the use of a fresh reference material every time you calibrate your instruments, to avoid the effects of hysteresis and oxidation on the Curie Point of the reference standards.



Description	Part No.
Alumel Reference Standard (154.2°C)	09988015
Nickel Reference Standard (355.3°C)	N5190869
Perkalloy Reference Standard (596°C)	N5190616
Iron Calibration Standard (770°C)	N5320112
Iron Reference Standard (780°C)	09988017
Histat-50 Reference Standard (1000°C)	09988019*
Cobalt Reference Standard (1121°C)	N5320111*
Indium Calibration Standard	03190033
Tin Calibration Standard (232°C)	03190034

Description	Part No.
Lead Calibration Reference (328°C)	03190035
Zinc Calibration Reference (420°C)	03190036
Silver Calibration Reference (962°C)	N5370438
Aluminium Calibration Reference (660°C)	N5380057
Gold Calibration Reference (1064°C)	N5380058
Palladium Calibration Reference (1555°C)	N5380071
Kit of five Reference Standards: alumel, nickel, perkalloy, iron and cobalt (one of each)	N5320201
Calibration Weight (TGA 6, TGA 4000, STA 6000, STA 8000)	N5200042
Calibration Weight (100 mg) Calibrates the TGA7 and Pyris Standard and High-Temperature instruments	09908397
Reference Weight for TGA 8000 (100 mg)	09200501
Magnet, Curie Point Temperature Calibration for TGA 8000	N5370466
Magnet, Curie Point Temperature Calibration for TGA 4000	L9003439
Calibration Weight Standards Kit for NOACK Lubricating Oil Test	N5370140**

* Calibration Material for the TGA 8000.

** Used to calibrate a TGA or STA to perform ASTM test method D5800 for evaporation loss of lubricating oils by the NOACK method.

TGA 8000 Balance Tare Weights

Balance Tare Weights are used to calibrate the Furnace Balance Mechanism for the weight of the sample pans.



Balance Tare Weight, Medium
N5320129

Description	Part No.
Aluminum Oxide Powder, 1 oz.	N5320133
Balance Tare Weight, Small, 194 mg	N5320128
Balance Tare Weight, Medium, 226 mg	N5320129
Balance Tare Weight, Large, 272 mg	N5320130
Balance Mounting Plate O-Ring	N5322029

PYRIS 1 TGA Furnace and Balance Supplies

Furnace Accessories and Glassware

Description	Part No.
1 Thermocouple Assembly	03190253
2 Furnace Tube Outer Glass, pyrex	N5370459
Platinum Furnace Shield	03191628
3 Balance Tare Weight	N5190282
4 Cover O-Ring	09902163

Hangdown Wire Kits

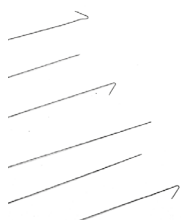

Hangdown Wire Kit, Nichrome N5190285

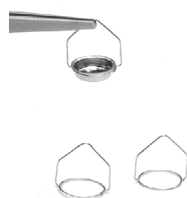

Stirrup Kit, Platinum

Description	Qty.	PYRIS 1 TGA Standard Part No.
5 Quartz Hangdown Wire Kit Includes wires with hooks on both ends, connecting the balance ribbon and the sample pan stirrup	5	N5370487
Quartz Hangdown Wire, Autosampler	5	N5370488
Hangdown Ribbon, Platinum	2	N5370478
Nichrome, preformed and straight wires, 0.01 mm OD	7	N5190285
Heavy NiChrome Wire, used to minimize buoyancy	5	N5370490
6 Stirrup Kit, Platinum, sample pans sit in the stirrup	4	03190265

PYRIS 1 TGA Pans, Liners, and Sealer

Description	Qty.	Part No.
7 Platinum Sample Pan Kit for PYRIS 1 TGA Standard	4	03190264
PYRIS 1 TGA Accupik Replacement Needle Kit	3	N5370554
Ceramic Liner Kit for PYRIS 1 TGA standard	6	N5190283
PYRIS 1 TGA Accupik Sample Pans and Covers	400	N5370550
Pyris TGA Volatile Capsule Sealer Kit		N5370555
Autosampler Ceramic Crucible Kit	10	N5370464
Disposable Aluminum Liners for Pyris 1 TGA Autosampler Ceramic Crucibles	400	N5370492

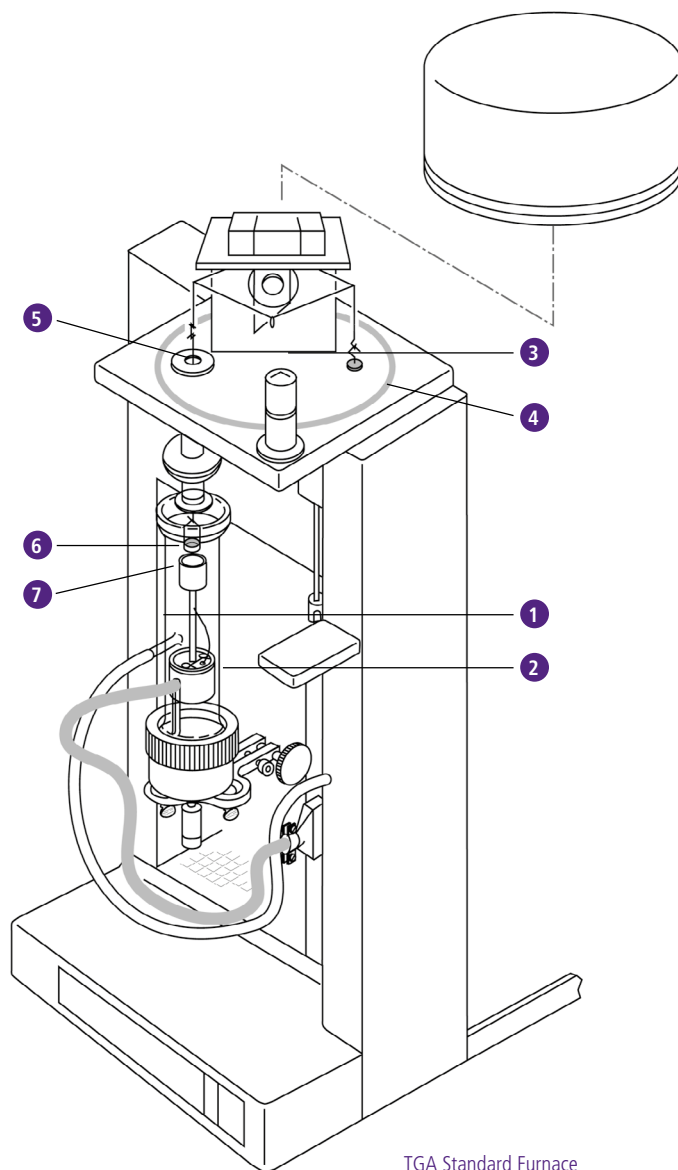

TGA Standard Furnace

Sub-Ambient Cooling Accessory Kit

When combined with the PolyScience Chiller (**N5370220** or **N5370221**), the Sub-Ambient Cooling accessory extends the PYRIS 1 TGA maximum low temperature to -20°C.

Included in this kit are ten feet of Tygon tubing (**02506518**), four hose clamps (**09903004**), one roll of Teflon tape (**09908739**), two Quick Connect Stems (**09920073**), six nylon tie wraps (**09940294**), and one glass tube (**N5370333**).



Description	Part No.
Sub-Ambient Cooling Kit	N5370553

PYRIS 1 TGA Tools and Replacement Parts

Description	Part No.
Hooked Forceps, non-magnetic	09908138
Straight Forceps, non-magnetic	09908400
PYRIS 1 TGA Accupik Replacement Needle Kit (pkg. 3)	N5370554

STA Accessories and Standards

The STA 6000 and STA 8000 deliver high productivity with reliable performance for routine analysis or research applications. PerkinElmer supports these units with high quality accessories, tools, and standards.



STA Accessories

Description	Part No.
STA 6000 Upgrade Kit Upgrades the STA 6000 to the STA 6000 with Autosampler	N5202103
Mini Dry Box, for non-autosampler units Recommended for use in humid conditions	N5202070
Mini Dry Box Sealing Gasket	N5202071
Large Dry Box, for Autosampler systems	N5202066
Large Dry Box Sealing Gasket	N5202067
AD 6500 Provetus Ultra-Microbalance	N5340016
Cable, Serial to USB	09410077
USB Cable	09241146
STA 6000 Spares Kit	N5200043*
STA 8000 Spares Kit	N5200039*

* Same contents as Spares Kit shipped with instrument.

STA Sample Pan Kits

These pans and lids work with the STA 6000, STA 8000, and the TGA 4000.

Description	Part No.
Sample Pans, Pt/Rh, 2.5 mm high (pkg. 5)	N5202103
Sample Pans, Pt/Rh, 5.0 mm high (pkg. 5)	N5201022
Sample Pans, Pt/Rh, 2.5 mm high (pkg. 1)	N5201023
Sample Pans, Pt/Rh, 5.0 mm high (pkg. 1)	N5201024
Ceramic Lids (pkg. 6)	N5202032
Ceramic Sample Pans (pkg. 3)	N5200040
Ceramic Sample Pan Kit (pkg. 45)	N5200045

STA Furnace Spares and Tools

Description	Model	Part No.
SaturnA Sensor	STA 6000	N5202083
Sensor	STA 8000	N5202007
ALSiFlex (pkg. 5)	STA 6000	N5376819
Ceramic Furnace Cover Ring	STA 6000	N5376800
Furnace Lid, for units without the Autosampler	STA 6000	N5376802
Furnace Lid, for units with the Autosampler	STA 6000	N5203153
Furnace Lid Assembly	STA 8000	N5202024
Furnace Lid Insulation Kit, includes replacement insulation for cover and 3 screws	STA 8000	N5202029
Calibration Weight	STA 6000/8000	N5200042
Forceps, Flat Tipped, Serrated	STA 6000/8000	N5202032
Narrow Tipped Tweezers	STA 6000/8000	N5361078
Tweezers, Flat Forceps	STA 6000/8000	09908400
Spirit Level	STA 6000/8000	N5202088
Aluminum Oxide Powder, 28 g	STA 6000/8000	04190197
Shipping Tool	STA 6000	N5203117
Shipping Tool	STA 8000	N5202122

STA Metal Reference Standards

Description	Nominal Temperature °C	Part No.
Indium	156.6	03190033
Tin	231.9	03190034
Lead	327.5	03190035
Zinc	419.5	N5340229
Silver	961.8	N5370438
Aluminum	660.3	N5380057
Gold	1064.2	N5380058
Palladium	1554.9	N5380071

DMA 8000 Accessories

The cost-effective Dynamic Mechanical Analyzer (DMA) is ideal for routine quality testing in the polymers, composites, pharmaceutical, and food industries. PerkinElmer offers a wide variety of accessories and consumables to expand its capabilities.

Liquid Nitrogen Cryo Dewar Accessory

The Liquid Nitrogen Cryo Dewar Accessory, a double-walled container through which a coolant flows, such as liquid Nitrogen, expands the sub-ambient temperature range of the DMA 8000 to temperatures as low as -196°C. This accessory is available as one- or fifty-liters Dewars. The 1-liter Dewar is ideal for occasional cooling experiments, while the 50-liter unit is optimal for more demanding cryogenic applications. The Auto Cryo Kit supplies a cryogenic valve, allowing the DMA 8000's AutoCryogenic Port to control the flow of coolant through the coolant line.



Liquid Nitrogen Cryo Dewar, 1L
N5330254

Description	Part No.
Liquid Nitrogen Cryo Dewar, 1 L	N5330254
Liquid Nitrogen Cryo Dewar, 50 L	N5330210
Auto Cryo Kit	N5330259*

* Automatic control is needed for sub-ambient isothermal experiments.

PolyScience Chillers

The optional Chiller accessory improves the temperature control of experiments conducted in the DMA 8000 Fluid Bath Accessory (N5330270) and extends the bath's sub-ambient temperature range. Depending on the coolant used, the Fluid Bath can reach a maximum low temperature of:

10°C – Distilled H₂O

0°C – Ethylene Glycol 30%/ H₂O 70%

-20°C – Ethylene Glycol 50%/ H₂O 50%



PolyScience Chiller
N5370220

Description	Part No.
PolyScience Chiller Fluid Bath only, 120 V	N5370220*
PolyScience Chiller Fluid Bath only, 220 V	N5370221*

* Requires, but does not include, tubing for the DMA 8000.

DMA 8000 Fluid Bath Accessory

As an integral part of the analyzer, the DMA 8000 Fluid Bath Accessory allows for true immersion studies on a sample while measuring dynamic mechanical properties. All geometry modes are supported in immersion mode. This accessory replaces the standard environmental chamber and allows the sample to be immersed in a fluid during the experiment. The temperature range of the Fluid Bath is -196°C (lowest temperature, achieved with liquid N₂ as the coolant). This accessory includes one Service Collar (N5331298), one Bath Chamber (N5331083), an optional Lifting Mechanism, the hardware required for assembly, and safety/use/assembly instructions.



DMA 8000 Fluid Bath Accessory with Lifting Mechanism N5330270

Description	Part No.
DMS 8000 Fluid Bath Accessory	N5330270

Humidity Generator

The Humidity Generator regulates of the relative humidity of clean, ambient air for routine humidity experimentation. The accessory flows ambient air through an integrated desiccant reservoir to clean the air. Next, it diverts a portion of this air through an 80 mL heated water reservoir and then through a heated connection tube to the DMA analyzer.



Humidity Generator N5330411

Features include:

- Temperature Range: 5–85°C.
- Relative Humidity Control Range: 5–90% at 25°C; 10–85% at 85°C.
- Independently dry air, no external gas supply needed.
- Easy control via touch screen or optional software.

Description	Part No.
Humidity Generator	N5330411*
Humidity 85/85 Chamber	N5330401**

* Requires, but does not include, the DMA 8000 Fluid Bath Accessory (N5330270) for routine humidity applications.
** Required accessory to the Fluid Bath (N5330270) for temperature operation above 70°C or RH experiments above 70%.

Measuring System for Tablets

This accessory is designed for holding a wide variety of non-flat tablets, capsules, and pills in compression. One side is V-grooved: the other has a round groove. It can be used with the DMA 8000 Fluid Bath Accessory (N5330270), the Humidity Generator (N5330411), and the DMA 8000 furnace.

Description	Part No.
Measuring System for Tablets	N5330604

High-Temperature Replacement Furnace

PerkinElmer offers a High-Temperature Replacement Furnace for the DMA 8000. This furnace has no optical windows and temperature range of -190–600°C.

Description	Part No.
High-Temperature Replacement Furnace	N5330268

Photo Accessory

Using the Photo Accessory, the study of both photo-initiated curing reactions and the degradation of the samples can to be observed through the Quartz window of the DMA 8000's environmental chamber. This accessory includes an Exfo OmniCure™ 2000 UV light source and a high-power fiber light guide with dual leg configuration that splits the light beam into two. A photo feedback system maintains constant lamp intensity, thus assuring accurate and consistent sample exposure for all measurements.

Description	Part No.
Photo Accessory	N5330612

Quartz Shear Adapter

The Quartz Shear Adapter is a set of replacement shear fixtures that use quartz studs and center disk to support UV irradiation or NIR measurements.

Description	Part No.
Quartz Shear Adapter	N5330075

Spares and Accessory Kit

PerkinElmer provides the Spares and Accessory kit to ensure that you have the replacement hardware and tools you need to operate the DMA 8000. Kit includes an extra power cord, a USB cable, a tool kit, a calibration weight set, and a caliper.

Description	Part No.
Spares and Accessory Kit	N5330600

Sample Handling Accessories



Material Pockets

Material Pockets

These unique sample preparation tools are designed specifically to hold non-self-supporting materials, such as powdered drugs, gels, natural products (e.g., tea leaves), and low viscosity materials for DMA analysis.

Description	Part No.
Material Pockets (pkg. 10)	N5330322
Material Pockets (pkg. 100)	N5330323
Material Pockets (pkg. 1000)	N5330324

Mesh Pockets

These innovative sample holders allow moisture or solvents to pass through non-self-supporting samples such as pharmaceuticals, teas, and paints.

Description	Part No.
Mesh Pockets (pkg. 25)	N5330177
Mesh Pockets (pkg. 100)	N5330178

DMA 8000 Systems Replacement Parts

PerkinElmer supplies replacements parts for the DMA 8000 accessories, or systems, to keep these systems performing at their best.

Fluid Bath Accessory Parts

Description	Part No.
Pyrex® Cup for Fluid Bath (pkg. 3)	N5330320
Rod Microswitch Extension	N5331098
Replacement Collar for use with Humidity Generator (N5330411)	N5331303
Replacement Aluminum Cup (Beaker) for the Fluid Bath	N5330068

Photo Accessory Replacement Parts

Description	Part No.
Replacement Omnicure® S2000 UV Lamp (Replacement Bulb)	N5365049
Replacement Omnicure Light Pipe	N5365048

Humidity Generator Accessory Parts

Description	Part No.
Desiccant Bottle for Humidity Generator (70 mL) with a 500 g UOP molecular sieve	N5331310
Humidity Sensor Assembly with Mounting Flange	09291680
Heated Moisture Supply Line	N5331308
Humidity Sensor Cable	N5331309
Desiccant for Humidity Chamber (1 kg)	N5330405*
Humidity Generator Sensor – Calibrated	N5330402*
Humidity Generator Heated Line	N5330403*
Humidity Generator Sensor Lead	N5330404*

*Compatible with the previous generation Humidity Generator (N5330400).

Measuring Systems Replacement Parts

The DMA 8000 comes with a complete set of standard fixtures to allow tension, bending (3 types), shear and compression experiments. These standard parts are also available for purchase as replacements and spares.



Description	Part No.
Screw Set, Socket Head Screws used to secure the Geometry Disk, 6 mm (pkg. 4)	N5330338
Side Pillars and Screw	N5365048
This kit includes two Socket Head screws and two stationary pillars	N5330303
Outer Clamp Support, Single Pillar (single) with one screw	N5330304
Compression Insert, Titanium (pkg. 1)	N5330308
Bending Clamp Set, Titanium (pkg. 5)	N5330300
Shear Clamp Outer Assembly (pkg. 2)	N5330302
3 Point Bend Assembly, one Titanium Knife Edge	N5330305
Terminator Assembly for the DMA 8000 Drive Shaft	N5330309
Extended Bending Clamp Set, Titanium (pkg. 4)	N5330306
Miniature 3 Point Bending Clamp, Aluminum	N5330307
Tablet Measuring System, includes a Tablet Moving Plate and a Tablet Fixed Plate	N5330604
Tablet Moving Plate	N5331243
Tablet Fixed Plate	N5331244
Alignment Fixture, Stainless Steel	N5330314
Shear Studs and Plate Set	N5330301
Extended Nut Set, Stainless Steel (pkg. 10)	N5330310
Full Nut Set, hexagon, varied sizes	N5330311
Tensile Spacer Set, Stainless Steel, includes 5 mm spacers (pkg. 4) and 8 mm spacers (pkg. 4)	N5330313
Torque Driver	N5335012
Thumb Screw, Stainless Steel, 18.5 mm long, for the Environmental Chamber Clamp	N5331136

DMA Furnace and Furnace Parts

Description	Part No.
Standard Furnace with Quartz Windows, maximum temperature of 400°C	N5330267
High Temperature Furnace, maximum temperature of 600°C	N5330268

DMA 8000 Calibration Standards

Description	Part No.
PMMA Test Sample (set of 5)	N5330316
Steel Test Sample	N5330317
PVC Test Sample (set of 5)	N5330340
HDPE Test Sample (set of 5)	N5330341
Polycarbonate Test Sample (set of 5)	N5330342
PET Film Test Sample (set of 5)	N5330343
G10 Epoxy Test Sample (set of 5)	N5330344
Septum for Compression (Set of 5)	00090652
Calibration Mass	N5330315
Temperature Calibration Kit Kit Includes: Indium wire (1.5 mm dia), PMMA test sample (pkg. 5) and FEB tube	N5330318
Traceable Calibration Kit, DMA Testing Kit Kit Includes: Micrometer Caliper, Calibration Mass, PMMA Test Sample Kit (pkg. 5) Feeler Gauge, Indium Wire Sample (pkg. 2) and PTFE Tube	N5330319
Measuring System Training Kit Kit Includes: Training Manual, Fairprene Septum Kit, Acrylic Sample (pkg. 5), PVC Sample (pkg. 5), HDPE Sample (pkg. 5), Polycarb Sample (pkg. 5), PET Sample (pkg. 5) and G10 Sample (pkg. 5)	N5330220
Dynamic Mechanical Analysis: A Practical Introduction (Menard)	N5374092

Specialty Fixtures and Accessories

Special problems often require special tools and a wide range of options exist for the DMA 8000. Advanced software for special tasks, clamps for tablets, material pockets, photo-adaptor for UV studies and fixtures that allow you to use the DMA 7 fixtures in the DMA 8000 are all available.

Description	Part No.
Measuring System for Tablets For holding non-flat tablets, capsules and pills in compression. Can be used with the fluid bath or the humidity chamber as well as the standard furnace. One side is V-grooved and the other side has a round groove to allow a wide range of specimens to be held	N5330604
DMA 7e Fixture Adapter Allows use of DMA 7 fixtures in DMA 8000	N5330613
DMA Photo Adapter Allows use of DSC UV system light guides with DMA 8000	N5337024

TMA 4000 Accessories



PerkinElmer offers a complete portfolio of consumables, accessories, and supplies that deliver optimal performance in measuring the coefficient of thermal expansion (CTE), T_g, and TM in materials. Choose from a range of accessories, consumables, and supplies with a cost efficient range of probes including expansion, compression, flexure, extension, and volumetric (dilatometry).

PolyScience Chiller

The optional Chiller accessory is a recirculating fluid bath of coolant pumped through lines to a recirculation chamber bolted to the TMA 4000. Depending on the coolant used, the Chiller can produce a minimum low temperature of:

10°C – Distilled H₂O

0°C – Ethylene Glycol 30%/ H₂O 70%

-20°C – Ethylene Glycol 50%/ H₂O 50%



PolyScience Chiller
N5370220

Description	Part No.
PolyScience Chiller, 120 V	N5370220
PolyScience Chiller, 220 V	N5370221

Intracooler II for TMA 4000

The Intracooler II is a fully sealed, refrigeration unit with coolant mediums sealed inside the system. Using a coolant similar to Freon, this unit provides low-term, low-maintenance cooling with low operating expenses. It only requires electrical power and is an excellent cooling option for laboratories without access to liquid nitrogen but have applications that require low temperatures or fast-cooling rates. Lowest minimal temperature -96°C. This unit comes standard with a TMA 4000 Insulation kit (L8041840), a 5 oz Heatsink Compound tube (09987122) and use instructions.

Description	Part No.
Intracooler II for TMA 4000, 100 V, 60 HZ	L8040020
Intracooler II for TMA 4000, 120 V, 60 HZ	L8040021
Intracooler II for TMA 4000, 240 V, 50 HZ	L8040022

Turbulent Chamber Kit

The Turbulent Chamber Kit, also called the Water Circulator Puck kit, uses cold tap water or a water circulator to maintain sub-ambient temperatures for experiments requiring colder, but above-freezing environments. This kit contains twenty-four feet of round Tygon tubing (02506519), four stainless steel hose clamps (09903004), and the Turbulent Chamber assembly (04190367).



Description	Part No.
Turbulent Chamber Kit	L8040201

TMA 4000 Kits

PerkinElmer provides complete sets of all the products the TMA 4000 requires for the proper handling and analysis of samples.



Description	Part No.
TMA Analysis Kit Contains a variety of sample pans and tubes, prob assemblies, Indium, Zinc, and Aluminum calibration/reference standards, and spare tubing	L8040200
Advanced Analysis Kit Contains a synthetic sapphire standard disk, a Quartz TMS Dilatometer Kit, the TMA Analysis Kit, the Extension Kit, Aluminum Oxide Powder, and a selection of probes and tubes	L8040202
Extension Kit Contains the probes, fixtures, clamps, and standards necessary to support TMA 7 functionality on the TMA 4000 instrument	N5190619
Quartz Dilatometer (sm) Kit Contains a Barrel and Plunger Dilatomerter cell, a vial of AL2O3, and use instructions	03190461
Bending Kit Contains a variety of sample handling probes, tubes, a stainless steel Knurled Nut Collar, shims of 45° and 90°, and kit instructions	N5390137

TMA 4000 Probes

The probes and fixtures listed here support special analysis on the TMA 4000. All of these products are also included in the TMA 4000 kits listed above and can be ordered as replacement parts to keep these kits complete.



Description	Analysis Kit	Part No.
Expansion Probe	TMA 4000 Analysis Kit	N5190378
Extension Probe	Extension Kit	N5190609
Flat Tip Penetration Probe	TMA 4000 Analysis Kit	N5190376
Flexure TMA Kit	Advanced Analysis Kit	N5190399
Flexure Probe – 3 Point Bending	Bending Kit	N5190393
Short Expansion Probe	Advanced Analysis Kit	L8041800
Round Tip Probe – 0.5 mm	Advanced Analysis Kit	N5190377
Round Tip Probe – Large	Advanced Analysis Kit	N5190416

Sample Tools

Complete sets of all the parts necessary for analysis of samples.

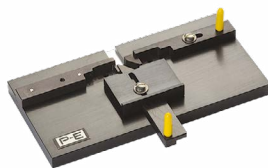

Description	Part No.
Aluminum Oxide Powder (1 oz bottle)	04190197
3 Point Bending Tube, Quartz, 10 mm	N5391181
Ceramic Furnace Top	L8041808
Copper Film/Fiber Mounting Pins (pkg. 100)	02190322
Dilatometer (sm) (Barrel and Plunger Set, Quartz)	03191705
Extension Tube (Fused Quartz)	N5191700
Extension Sample Clamp	N5190611
Halocarbon Oil (27 g)	L9004783
Knurled Nut Collar for Sample Tube (Stainless Steel)	N5391054
Quartz Sample Tube	N5191549
Sample Mounting Fixture	N5190615
Sample /Furnace Thermocouple	L8041809
Split Collar for Sample Tube (Ferrule)	N5191662

Reference Standards

Below are the reference standards and calibration standards necessary to keep the TMA 4000 instrument performing at its best.



Sapphire Disk **02191269**

Description	Part No.
Aluminum Standard Expansion 10 mm x 3 mm	L8041600
Aluminum Standard Expansion 5 mm x 3 mm	L8041601
Indium Temperature Calibration Material, 0.125 oz wire	03190033
Quartz Displacement Standard, diameter 0.25 in.	N5391051
Sapphire Disc – Thin Expansion Standard, diameter 0.25 in.	02191269
Test and Calibration Weight Set	L8041801
Zinc Temperature Calibration Material (Foil Square)	N5340229
Zinc Temperature Calibration Sample Kit Contains one 6 mm Calibration disk, one Zinc 100 mm Foil Square, one Aluminum Sample Pan and Cover Kit (400 pans/covers), and use instructions	03190036

Spares

PerkinElmers offers the following sampling tools, hardware, and other useful consumables as replacements or spares to help keep both the TMA 4000 and its accessories running smoothly.



Sample/Furnace Thermocouple
L8041816

Description	Part No.
Non-Magnetic Tweezers (Straight)	09908400
Furnace Fuse, 110V AC	L8041802
Furnace Fuse, 220V AC	L8041803
Hose Clamps, Stainless Steel (pkg. 4)	09903004
Tape: High Temperature	02507907
Tape: Thread Sealant	09908134
PTFE Tubing: 1/8" OD x 1/16" ID	02506483
Sample/Furnace Thermocouple	L8041816
Tygon Clear Tubing: 1/2" OD x 3/8" ID	02506519
1/8" Swageloc Fittings (pkg. 2)	09903906
Restrictor: Air	01541496
Restrictor: Hydrogen-Oxygen	01541498
Furnace Topper, Ceramic	L8041838

EGA Hyphenation

Evolved Gas Analysis (EGA) Hyphenation enables in-depth characterization of evolved gases. The PerkinElmer TL interface series hyphenates (or couples) Thermogravimetric (TG) instrument with two or more additional analytical instruments. EGA uncovers results and insights not possible with the individual instruments alone. PerkinElmer's Thermogravimetric instruments can be coupled with Fourier Transform Infrared (FT-IR), Mass Spectrometry (MS) and/or Gas Chromatography/Mass Spectrometry (GC/MS) spectrometers, resulting in a deeper understanding of how a material degrades or what gases evolve when the material decomposes.

Model Number	Instrument Series
TL 8000e	TG-IR
TL 8300e	TG-MS
TL 8500e	TG-GC, TG-GC/MS
TL9000e	TG-IR-GC/MS

EGA Hyphenation is a powerful tool in the analysis and identification of complex mixtures, both known and unknown. These technologies help advance the power of analysis in a laboratory.

Applications

- Polymers and Chemical Identification.
- Petroleum, Pharmaceuticals, Food, Environment and Soil Analysis.
- Material Characterization.
- Solid State Characterization (Polymorphism/Pseudopolymorphism).
- Microplastic Research.
- Product Packaging.
- Nanotechnology Research.
- Product Development.
- Reverse Engineering.
- Quality Control/Quality Assurance.
- Basic and Applied R&D.



TL 8000e



TL 8300e



TL 8500e



TL 9000e

THERMAL ANALYSIS

TL 8000e TG-IR Selection Chart

Thermogravimetric Analyzers						FT-IR Analyzers		Part Number	
TGA 8000	TGA 4000	STA 8000	STA 6000	Pyris 1 TGA	Pyris 1 TGA-HT	Spectrum 3*	Spectrum 2	120V 60Hz	230V 50Hz
√						√		L8200061	L8200062
√							√	L8200063	L8200064
	√					√		L8200051	L8200052
	√						√	N5370015	N5370016
		√				√		L8200057	L8200058
		√					√	L8200059	L8200060
			√			√		L8200051	L8200052
			√				√	N5370015	N5370016
				√		√		L8200053	L8200054
				√			√	L8200055	L8200056
					√	√		L8200065	L8200066

TL 8300e TG-MS Selection Chart

Thermogravimetric Analyzers						MS	Part Number	
TGA 8000	TGA 4000	STA 8000	STA 6000	Pyris 1 TGA	Pyris 1 TGA-HT	SQ8	120V 60Hz	230V 50Hz
√						√	N5320061	N5320062
	√					√	N5320063	N5320064
		√				√	N5370745	N5370746
			√			√	N5320063	N5320064

TL 8500e TG-IR TG-GC/MS Selection Chart

Thermogravimetric Analyzers					GC		MS	Part Number	
TGA 8000	TGA 4000	STA 8000	STA 6000	Pyris 1 TGA	Clarus 590	Clarus 690	SQ8	120V 60Hz	230V 50Hz
√					√	√	√	L8200086	L8200087
	√				√	√	√	L8200082	L8200083
		√			√	√	√	L8200084	L8200085
			√		√	√	√	L8200082	L8200083
				√	√	√	√	L8200080	L8200081

TL 9000e TG-IR-GC/MS Selection Chart

Thermogravimetric Analyzers						FT-IR Analyzers		GC		MS	Part Number	
TGA 8000	TGA 4000	STA 8000	STA 6000	Pyris 1 TGA	Pyris 1 TGA-HT	Spectrum 3*	Spectrum 2	Clarus 590	Clarus 690	SQ8	120V 60Hz	230V 50Hz
√						√		√	√	√	L8200112	L8200113
√							√	√	√	√	L8200114	L8200115
	√					√		√	√	√	L8200100	L8200101
	√						√	√	√	√	L8200102	L8200103
		√				√		√	√	√	L8200108	L8200109
		√					√	√	√	√	L8200110	L8200111
			√			√		√	√	√	L8200100	L8200101
			√				√	√	√	√	L8200102	L8200103
				√		√		√	√	√	L8200104	L8200105
					√	√		√	√	√	L8200106	L8200107

* Use with Spectrum 3 and the following prior models: Frontier & Spectrum 65/100/400/One series.

TL 8000e TG-IR Series



The TL 8000e TG-IR enables the hyphenation of a TGA analyzer with an FT-IR spectrometer. A transfer line moves gases generated in the thermal analyzer to an FT-IR instrument for identification and quantification. The TL's state-of-the-art design ensures constant gas flow, optimally separates time-resolved peaks, and reduces mixing of IR signals.

Included in this TL series is a:

- **Thermal Analyzer Adapter** – This Adapter is the interface connection between the thermal analyzer and the Digital Controller. It is designed to maximize results and minimize dead volumes in the analyzer's furnace. It provides exhaust tube connections and isolates the furnace from oxygen and moisture. TL 8000e adapters are currently available for TGA 8000 /TGA 4000/STA 8000/ STA 6000/ Pyris 1/Pyris 1 High Temperature furnace*.

* Inquire about additional options.

- **FT-IR Cell** – This cell has a special "Zero Gravity Cell" design that supports constant gas flow by providing gas input valves at the top of the cell and exhaust ports at the bottom of the cell. This design reduces the accumulation of heavy compounds on the KBr windows, lowering maintenance and increasing cell life and usability. Cells currently available Frontier and Spectrum 3/65/100/400/One series FT-IR.



- **Digital Controller, Pump & filters**

– The Digital Controller controls the pressure, temperature, mass flow, flow smoothing system, and FT-IR triggers. From the Controller's seven-inch touchscreen, you can easily recalibrate the mass flow controller (MFC), set pump threshold activations, and view diagnostic information such as alerts and notifications. The Controller is web server enabled.



The TL 8000e design enables the TGA and FT-IR instruments to easily interchange between standalone or hyphenated analysis. The TL 8000e TG-IR Selection Chart on [page 128](#) lists the various configurations available for this series.

TL 8000e TG-IR Kits

PerkinElmer supplies upgrade kits and maintenance kits for the TL 8000/TL 8000e hyphenated series running smoothly and optimally.

TL 8000e Digital Controller & Pump Upgrade

The TL 8000e Digital Controller & Pump Upgrade upgrades an existing TL 8000 EGA series to the Digital TL 8000e series. Requires, but does not include, the following parts: an EGA Transfer Line, an IR Cell, and a Relay Box (**N5370060**). This kit is easily self-installed.

Description	Part No.
Digital Controller and Pump (120 V, 60 Hz), User Guide, and a one-year warranty	L8200244*
Digital Controller and Pump (230 V, 50 Hz), User Guide, and a one-year warranty	L8200245*

* Requires, but does not include, a software upgrade.

TL 8000 & TL 8000e TG-IR Interface Maintenance Kit

The TG-IR Interface Maintenance Kit provides replacement parts and spares for both the TL 8000 and the TL 8000e models. The kit includes the following products: BFHTL Zero Gravity Cell KBr windows, 25 x 4 mm (pkg. 2) (**L8201801**); BFHTL Disposable Coarse Filter Replacement (**L8201804**); BFHTL Tubular Filter (**L8201805**); Coalescent Disposable Fine Filter (**L8201813**); BFHTL Zero Gravity Cell O-Ring, 350°C (**L8201818**), O-Ring IR Cell, graphite (pkg. 4) (**L8201821**); BFHTL PTFE Exhaust Tube (**L8201825**), BFHTL Transfer Line End O-Ring (**L8201881**), and Anti-Seizing Paste (**09200654**).

Description	Part No.
TL 8000e TG-IR Interface Maintenance Kit	N5320204

TL 8300e TG-MS Series



The TL 8300e TG-MS enables the hyphenation of a TGA analyzer and a Mass Spectrometer. TG-MS hyphenation supports the detection of very low levels of impurities in active gas samples, providing highly sensitive analysis of complex compounds. It is very useful for identifying polymers, verifying environmental product quality, and detecting residual solvents and pesticides. The TL 8300e transfer line moves gases from the TGA 8000, TGA 4000, STA 6000, or STA 8000* analyzer to the PerkinElmer SQ8 Mass Spectrometer for identification and quantification.

* Inquire about additional options.

Included in this TL series is a:

- **Thermal Analyzer Adapter** – This Adapter is the interface connection between the thermal analyzer and the Digital Controller. It is designed to maximize results and minimize dead volumes in the analyzer's furnace. It provides exhaust tube connections and isolates the furnace from oxygen and moisture. The adapter provided is specific to your Thermal Analyzer.
- **Single Valve Glock for MS (GSV1)** – This accessory easily installs on the MS bracket. Its high-temperature valve design protects the MS unit when the analyzer is open or not in use. It also allows the SQ 8 to be continually flushed with Helium.
- **Digital Controller, Pump & filters** – The Digital Controller controls the pressure, temperature, mass flow, flow smoothing system, and TG-MS triggers. From the Controller's seven-inch touchscreen, you can easily recalibrate the mass flow control (MFC), set pump threshold activations, and view diagnostic information such as alerts and notifications. The Controller is web server enabled.



The TL 8300e design enables the TGA and MS instruments to easily interchange between standalone or hyphenated analysis. The TL 8300e TG-MS Selection Chart on [page 128](#) lists the various configurations available for this series.

TL 8300e TG-MS Kits

PerkinElmer supplies upgrade kits and maintenance kits for the TL 8300/TL 8300e hyphenated series running smoothly and optimally.

TL 8300e Digital Controller & Pump Upgrade

The TL 8300e Digital Controller & Pump Upgrade enables an existing TL 8300 EGA to gain the benefits of the Digital TL 8300e. Requires, but does not include, the following parts: an EGA Transfer Line, a Single GSV Block, and a Relay Box (**N5370060**). This kit is easily self-installed.

Description	Part No.
Digital Controller and Pump (120 V, 60 Hz), User Guide, and a one-year warranty	N5320069
Digital Controller and Pump (230 V, 50 Hz), User Guide, and a one-year warranty	N5320070

TL 8300e & TL 8300 TG-MS Interface Maintenance Kit

The TG-MS Interface Maintenance Kit provides replacement parts and spares for both the TL 8300 and the TL 8300e models. The kit includes the following products: a Ferrule Glass TBG, 0.4 mm (**09920104**); BFHTL Disposable Coarse Filter Replacement (**L8201804**); Coalescent Disposable Fine Filter (**L8201813**); BFHTL Transfer Line End O-Ring (**L8201881**); GSV Ferrule 0.25 mm VCT (**L8201957**) and five meters of Fused Silica Intermediate Polarity Tubing, 10 mm (**N9301355**).

Description	Part No.
TL 8300 & TL 8300e Maintenance Kit	N5320206

TL 8500e TG-MS, TG-GC/MS Series



The TL 8500e TG-GC/MS enables the hyphenation of a TGA analyzer and a Gas Chromatography/Mass Spectrometer (GC/MS). TG-GC/MS hyphenation enables detection of very low levels molecules from complex mixtures formed in the TGA analyzer. The TL 8500e interface transfers the evolved gases from the TGA analyzer, injecting the sample into the GC sampling loop for separation or directing it to the MS unit for ion detection and identification. Multiple event separation is possible and when hyphenated with the Clarus 690 FAST GC can be performed to save time. The TL-8500e Controller follows user-defined instructions to automatically switch analysis between the GC and MS instruments. The design enables the TGA and GC/MS instruments to easily interchange between standalone or hyphenated analysis. The TL-8500e is compatible with the following PerkinElmer thermal analyzers: TGA 8000, TGA 4000, STA 6000, STA 8000, and PYRIS 1 TGA analyzers*. And the Clarus 590 and 690 GC/MS.

* Inquire about additional options.

Included in this TL series is a:

- **Thermal Analyzer Adapter** – This Adapter is the interface connection between the thermal analyzer and the Digital Controller. It is designed to maximize results and minimize dead volumes in the analyzer's furnace. It provides exhaust tube connections and isolates the furnace from oxygen and moisture. The adapter provided is specific to your thermal analyzer.
- **Double Valve Block (GSV1GSV2) for GC/MS** – This component is an external oven installed over the PerkinElmer GC next to the FID position. It protects the GC/MS from the Thermal Analyzer and ensures that the MS unit is continually flushed with Helium.

• Digital Controller, Pump & filters

– The Digital Controller controls the pressure, temperature, mass flow, flow smoothing system, and TG-GC/MS triggers. From the Controller's seven-inch touchscreen, you can easily recalibrate the mass flow controller (MFC), set pump threshold activations, and view diagnostic information such as alerts and notifications. The Controller enables, automatic, staged injections of samples into the GC column, and is web server enabled.



The TL 8500e TG-GC/MS Selection Chart on [page 128](#) lists the various configurations available for this series.

TL 8500e TG-GC/MS Kits

PerkinElmer supplies upgrade kits and maintenance kits for the TL 8500/TL 8500e hyphenated series running smoothly and optimally.

TL 8500e Upgrade Kit

The TL 8500e Digital Controller & Pump Upgrade enables an existing TL 8500 EGA to gain the benefits of the Digital TL 8500e. Requires, but does not include, the following parts: an EGA Transfer Line, a Double GSV1GSV2 Block, and a Relay Box (**N5370060**). This kit is easily installed by the customer.

Description	Part No.
Digital Controller and Pump (120 V, 60 Hz), User Guide, and a one-year warranty	L8200078
Digital Controller and Pump (230 V, 50 Hz), User Guide, and a one-year warranty	L8200079

TL 8500e & TL 8500 TG-GC/MS Interface Maintenance Kit

Regular maintenance ensures optimal system performance. PerkinElmer provides the TL 8500e and TL 8500 TG-GC/MS Interface Maintenance Kit which supply the replacement parts and spares needed to keep both the TL 8500 and the TL 8500e running well. The kit includes the following products: BFHTL Disposable Coarse Filter Replacement (**L8201804**); Coalescent Disposable Fine Filter (**L8201813**); BFHTL Transfer Line End O-Ring (**L8201881**); GSV Ferrule 0.25 mm VCT (**L8201957**) and Teflon Tubing, 1/8 in. (**L8201950**).

Description	Part No.
TL 8500 & TL 8500e Maintenance Kit	N5320205

TL 9000e TG-IR-GC/MS Series



The TL 9000e TG-IR-GC/MS enables the hyphenation of a TGA analyzer, with an FT-IR, a Gas Chromatography and a Mass Spectrometer. TG-IR-GC/MS hyphenation enables the most in-depth characterization of evolved gases. The TL 9000 Transfer Line moves the gases evolved from the thermal analyzer to an FT-IR Spectrometer and/or GC/MS or to the MS directly. The multi-analysis of evolved gases using FT-IR, GC, and MS analyses enable maximum information about the sample. Multiple event separation is possible, and when hyphenated with the Clarus 690, FAST GC can be performed to save time.

The state-of-the-art design of the TL 9000e is a continuous and sequential system that delivers optimal separation between time-resolved peaks, reduced mixing of IR signals, no accumulation of heavy compounds in the IR cell, negligible dead volume in the TGA furnace, and ensures the isolation of the GC/MS units from the TGA furnace. The design enables the TGA, FT-IR, and GC/MS instruments to easily interchange between standalone or hyphenated. without decoupling the GC/MS.

The TL 9000e interfaces PerkinElmer thermal analyzers [TGA 8000, TGA 4000, STA 6000, STA 8000, PYRIS 1 TGA or PYRIS 1 HT TGA]

with,

PerkinElmer FT-IR spectrometers Frontier and Spectrum 3/65/100/400/One series FT-IR

with,

PerkinElmer Clarus GC 590 and Clarus GC 690

with,

PerkinElmer SQ8 MS

Included in the TL 9000e series is a:

- **Thermal Analyzer Adapter** – This Adapter is the interface connection between the thermal analyzer and the Digital controller. It is designed to maximize results and minimize dead volumes in the analyzer's furnace. It provides exhaust tube connections and isolates the furnace from oxygen and moisture. The adapter provided is specific to the analyzer.
- **FT-IR Cell** – This cell has a special "Zero Gravity Cell" design that supports constant gas flow by providing gas input valves at the top of the cell and exhaust ports at the bottom of the cell. This design reduces the accumulation of heavy compounds on the KBr windows, lowering maintenance and increasing cell life and usability. Cells currently available Frontier and Spectrum 3/65/100/400/One series FT-IR.

- **Double Valve Block (GSV1GSV2) for GC/MS** – This component is an external oven installed over the PerkinElmer GC next to the FID position. It protects the GC/MS from the Thermal Analyzer and ensures that the MS unit is continually flushed with Helium.

• Digital Controller, Pump & filters

- The Digital Controller controls the pressure, temperature, mass flow, flow smoothing system, and TG-IR/GC/MS triggers. From the Controller's seven-inch touchscreen, you can easily recalibrate the mass flow controller (MFC), set pump threshold activations, and view diagnostic information such as alerts and notifications. The Controller enables, automatic, staged injections of samples into the GC column, and is web server enabled.



The TL 9000e TG-IR-GC/MS Selection Chart on [page 128](#) lists the various configurations available for this series.

TL 9000e TG-IR-GC/MS Kits

TL 9000e Upgrade Kit

The TL 9000e Digital Controller & Pump Upgrade enables an existing TL 9000 EGA to gain the benefits of the Digital TL 9000e. Requires, but does not include, the following parts: an EGA Transfer Line, a Double GSV1GSV2 Block, and a Relay Box (**N5370060**). This kit is easily installed by the customer.

Description	Part No.
Digital Controller and Pump (120 V, 60 Hz), User Guide, and a one-year warranty	L8200116
Digital Controller and Pump (230 V, 50 Hz), User Guide, and a one-year warranty	L8200117

TL 9000e & TL 9000 TG-MS Interface Maintenance Kit

Regular maintenance ensures optimal system performance. PerkinElmer provides the TL 9000e and TL 9000 Interface Maintenance Kit which includes: BFHTL Zero Gravity Cell KBr windows, 25 x 4 mm (pkg. 2) (**L8201801**); BFHTL Disposable Coarse Filter Replacement (**L8201804**); Tubular Filter (**L8201810**); Coalescent Disposable Fine Filter (**L8201813**); BFHTL Zero Gravity Cell O-Ring, 350°C (**L8201818**); BFHTL Transfer Line End O-Ring (**L8201881**); GSV Ferrule 0.25 mm VCT (**L8201957**), Teflon Tubing, 1/8 in. (**L8201950**), and Anti-Seizing Paste (**09200654**).

Description	Part No.
TL 9500 & TL 9500e Maintenance Kit	N5320207

TL Series Consumable Parts

TGA 8000 High-Performance Hyphenation Tube

High Performance quartz enhancement tube is designed for use with TGA 8000 (only). It enables increased hyphenation sensitivity $\geq 10X$. Additionally, it helps keep the TGA outer glass clean for longer life and optimal performance.

Description	Part No.
TGA 8000 High-Performance Hyphenation Tube	L8201819

TGA 8000 Suction Tube

The TGA 8000 Suction tube can be used with all Transfer Line models using the TGA 8000 adapter. The longer 29 mm Suction tube helps to better reach the sample area and minimize dead volume inside the furnace. Used with the Slotted High-Performance Quartz Enhancement Tube (**L8201819**), it is the best way to minimize maintenance throughout the hyphenation interface line. With it, both the FT-IR cell and GC/MS GSV valves are cleaner.

Description	Part No.
TGA 8000 Suction Tube (one tube)	N5320203

Table Accessory for TL 9000e and TL 8000e

This table makes it easy to interchange IR accessories or run the FT-IR spectrometer as a stand-alone instrument; no need to remove transfer lines. For use with TL 9000e, TL 9000, TL 8000e, and TL 8000.

Description	EGA Series	Part No.
Table Accessory	TL 8000/800e/ 9000/900e	L8201012

KBr Replacement Windows Kits

The KBr Windows Kits supply sets of replacement KBR windows.

Description	Part No.
Zero Gravity KBr Windows 25 x 4 mm, 1 pair	L8201801
KBr Circular Windows, 25 x 4 mm, 1 pair	L1271202
Anti-Seizing Paste, 25 g tube	09905148

O-Rings for IR Cell

The O-Rings for IR Cell comes as a Graphite O-Ring for use with temperatures greater than 350°C and a Zero Gravity O-Ring for use with temperatures less than 350°C. Four O-Rings per package.

Description	Part No.
Graphite High Temperature O-Ring	L8201821
Zero Gravity O-Ring	L8201818

Transfer Line BFHTL O-Ring

The Transfer Line BFHTL O-Ring sits between the end of a Transfer Line and any TGA adapter.

Description	Part No.
Transfer Line O-Ring	L8201881

BFHTL Exhaust Tube

The BFHTL Exhaust Tube is a PTFE tube with a Ferrule.

Description	Part No.
BFHTL Exhaust Tube	L8201825

TL 9000 Teflon Tubing

The TL 9000 Teflon Tubing is a Silcosteel inner liner for the TL 9000 series transfer line. It comes in two sizes, 1 meter and 1.4 meters.

Description	Part No.
TL 9000 Teflon Tubing, 1 meter	L8201802
TL 9000 Teflon Tubing, 1.4 meters	L8201954

Transfer Line Tubing Kit (Product Header)

The Transfer Line Tubing Kit is a complete set of replacement tubes for hyphenated systems with GC/MS GSV valve blocks.

Description	EGA Series	Part No.
TL 9000 GSV Silcosteel Tube Kit. Complete kit of tubing, 1/16 in.	9000/9000e	L8201954

TL Ethernet Connection Cable

The Ethernet Connection Cable is 5 meters long and connects a TL series Controller to a computer to enable Web-server mode. Already included in EGA Installation kits, this cable can be ordered as a spare.

Description	Part No.
TL Ethernet Connection Cable	L8201007

Education Services to Help Accelerate Your Science



Invest in Instrument Training

You are under tremendous pressure to meet tight budget constraints while performing more experiments than ever. Due to these dynamics, instrument training can seem like a luxury versus a necessity, and important benefits can be overlooked.

Choose the Option That's Right for You:

Classroom Training

Conducted by faculty at PerkinElmer Centers of Excellence

- Courses ranging from the basics to advanced techniques
- Hands-on experience in a laboratory environment
- Peer networking and collaboration
- Small class size to ensure individual attention
- 1–5 day options

Basic Training: Operation Essentials

Conducted by a certified Service Engineer in your lab

- For the beginner to intermediate user
- Courses adapted to meet your lab's needs
- System overview and basic principles
- Hands-on training using your instruments
 - Operational techniques
 - Instrument optimization/maintenance
 - Software operations/data acquisition
- 1–3 day options; up to four users per session

Advanced: Optimization Training and Applications

Conducted by a specialized Field Application Scientist in your lab

- For the experienced user
- Courses designed to address your unique challenges
- Customized hands-on training
 - In-depth instrument and software operations
 - Method optimization
 - Application-specific, consultative training
- 1–5 day options; up to four users per session

PerkinElmer Education Services enables you to:

- Keep your instrument running at peak performance with less downtime.
- Discover new instrument capabilities.
- Advance your knowledge base and skill set.
- Overcome the unique challenges of your application.

For more information including custom training options:

Email OnSiteTraining@PerkinElmer.com Visit www.perkinelmer.com/OneSourceTraining

PerkinElmer OneSource Service Contracts



Improve your instrument investment and avoid the high costs associated with instrument failure with a OneSource® service plan. Unexpected instrument failure not only disrupts laboratory productivity, but can be expensive to fix. Choosing a service contract that provides breakdown coverage can help protect you from unexpected costs.

Regular preventive maintenance will help optimize your instrumentation, increasing the efficiency of your laboratory and extending the lifetime of your instrument. Consider combining your scheduled preventive maintenance with instrument qualification in a single visit to help minimize disruption to your laboratory.

We offer the most robust compliance solution in the industry. With our suite of qualification services covering many technologies, from a classical paper-based solution to a metrology-based approach, we can help your laboratory produce accurate and compliant results, day after day. deliver consistent digestion results.

- Ensure against the cost of unexpected instrument failure.
- Ensure optimum instrument performance.
- Control service costs.
- End users produce accurate and reproducible results.

Choose the OneSource Plan That's Right for your Laboratory

Platinum

For laboratories where instrument uptime is critical to performance. Includes a proactive alert system, for enabled instruments, that triggers corrective actions to help avoid equipment downtime and unnecessary expenses

Gold

Enhance laboratory productivity by maintaining instrument efficiency with priority response, remote technical support and regular preventive maintenance

Bronze

An excellent and cost-effective way to extend all the benefits of a first year instrument warranty

Features	Bronze Plan	Gold Plan	Platinum Plan
Response Time ¹	Priority over Billable	Priority Response	Highest Level Priority
PerkinElmer Certified Repair Parts ²	✓	✓	✓
Travel To Your Location ³	✓	✓	✓
Emergency Breakdown Visits	✓	✓	✓
Preventive Maintenance Visits	N/A	1 or 2 PM visits	1 or 2 PM visits
Technical And Remote Support	✓	✓	✓
Software Updates ⁴	✓	✓	✓
Radian™ Remote Monitoring ⁵	✓	✓	✓
OPTIONS			
Premium Qualification Solutions	N/A	optional	optional
24 Hour Response Time ⁶	N/A	N/A	optional
Training Discount ⁷	eligible for 5% discount	eligible for 10% discount	eligible for 15% discount
Upgrades Discount ⁸	eligible for 10% discount	eligible for 15% discount	eligible for 20% discount
Discount on New Purchase of Power Protection Unit ⁸	eligible for 10% discount	eligible for 15% discount	eligible for 20% discount
Consumables Discount ⁸	eligible for 5% discount	eligible for 10% discount	eligible for 15% discount

1. Priority response varies by region and is based on a 'best effort' basis. Please consult your local service engineers for additional information.

2. Excludes all consumables. Certain parts may also be excluded based on instrument type. Please contact your local service engineer for details.

3. Zone 1 travel is 100% included in all Service Plans. Travel outside Zone 1 may incur additional travel costs.

4. Software updates do not include software upgrades.

5. For Radian enabled instruments. Service Contract discount available on instruments monitored by Radian.

6. Only available to select Platinum Plan customers. Please consult your local service manager for availability and pricing.

7. Excludes training related to the following products: Informatics, diagnostics, all imaging instruments, automation and liquid handling, high content screening, radiometric detection, newborn screening, and microplate readers.

8. Discounts may not be available for all products or product lines. Please consult your local service engineers for additional information.

Visit www.perkinelmer.com/servicecontracts



PART NUMBER INDEX

Part No.	Page	Part No.	Page	Part No.	Page
00090037.....	96	02401347.....	97	6005290.....	91
00090652.....	124	02401362.....	95, 96, 97	6005299.....	91
00090709.....	96, 102	02401375.....	96	6008103.....	36
01541496.....	119	02401583.....	100, 101	6008104.....	36
01541498.....	119	02402089.....	96, 101	7002356.....	36
01860436.....	31	02506483.....	126	7005386.....	36
01860796.....	22	02506515.....	119	7005397.....	36
01860954.....	23	02506518.....	117, 119, 121	7005398.....	36
01862289.....	31	02506519.....	125, 126	7607537.....	36
01862295.....	31	02507907.....	126	09200501.....	116, 119
01862301.....	35	03190021.....	114	09200654.....	129, 132
02190041.....	112	03190025.....	113	09241146.....	121
02190042.....	113	03190026.....	113	09291680.....	124
02190045.....	115	03190029.....	112, 114	09402019.....	110, 116
02190048.....	112, 113	03190030.....	113, 115	09402020.....	110, 116
02190061.....	102, 112, 114	03190031.....	113, 115	09410077.....	121
02190062.....	114	03190033.....	115, 119, 121, 126	09902029.....	96
02190080.....	114	03190034.....	115, 119, 121	09902035.....	100
02190136.....	114	03190035.....	115, 119, 121	09902048.....	96, 100
02190322.....	126	03190036.....	115, 119	09902123.....	96, 100
02191171.....	113	03190218.....	112, 114	09902133.....	96, 103
02191269.....	126	03190236.....	114	09902163.....	120
02191295.....	114	03190253.....	120	09902188.....	96, 100
02191296.....	114	03190264.....	120	09903004.....	117, 121, 125, 126
02192005.....	112	03190265.....	120	09903087.....	119
02200550.....	26	03190461.....	125	09903094.....	119
02400083.....	97	03191047.....	112, 114	09903117.....	119
02400084.....	99, 117	03191628.....	118, 120	09903150.....	99, 119
02400085.....	117	03191705.....	126	09903174.....	96
02400115.....	97	04190197.....	121, 126	09903196.....	119
02400117.....	96, 97	04190299.....	113, 115	09903422.....	96
02400119.....	97	04190367.....	125	09903471.....	99
02400137.....	100, 101	04800514.....	31	09903482.....	119
02400642.....	96, 102	04810949.....	31, 35	09903665.....	101, 103
02400815.....	97	04821008.....	25, 38, 39	09903673.....	96, 101, 103
02401028.....	100, 101	04821131.....	25	09903906.....	119, 126
02401042.....	96, 100, 101	04821132.....	25	9904866.....	98
02401092.....	97	04960691.....	35	09905148.....	133
02401117.....	97	04967843.....	35	09907204.....	96, 103
02401118.....	98	04967845.....	26, 35, 38, 39	09907207.....	96, 103
02401119.....	97	04967854.....	35	09908134.....	126
02401120.....	97	04969486.....	83	09908138.....	96, 103, 115, 118
02401121.....	95, 97	04974438.....	35	09908138.....	121
02401286.....	96, 103	04977042.....	31	09908216.....	99
02401286.....	118	04977043.....	31, 35	09908397.....	119
02401291.....	101	04978499.....	84, 87	09908400.....	96, 103, 115, 116, 118, 121
02401293.....	101	5079076.....	36	09908467.....	112, 114
02401294.....	96, 103	5085685.....	36	09908739.....	117, 121
02401296.....	96, 103	05370221.....	117	09908777.....	118
02401296.....	118	6005270.....	91	09908854.....	96
02401344.....	97	6005279.....	91	09920026.....	119

PART NUMBER INDEX

Part No.	Page	Part No.	Page	Part No.	Page
09920073.....	117, 121	B0071519	69	B0501078	96, 102
09920104.....	130	B0079413	60	B0501282	74
09920220.....	117	B0080171	65, 68	B0505071	61
09920230.....	117	B0080819	68, 65	B0505284	74
09920404.....	100	B0080821	61	B0505340	112, 113, 114
09923121.....	99	B0080822	62	B0505530	69, 74
09923423.....	117	B0082539	59, 61	B0505982	55
09923480.....	116	B0086703	62, 69	B0507805	78
09940294.....	117, 121	B0089439	63, 64	B0508901	36, 76, 90
09972329.....	83	B0094014	63	B0508921	112, 113, 114
09972337.....	83	B0114615	55	B0509546	75
09981610.....	96	B0114620	55	B0509591	75
09981611.....	96	B0137314	62, 69	B0510366	66, 67
09981619.....	96	B0139005	112, 113	B0510412	66
09981788.....	96	B0139033	113	B0510581	55
09987122.....	125	B0139122	113, 115	B0613134	56
09988015.....	119	B0142512	115	B0631001	56
09988017.....	119	B0143003	112	B0631002	56
09988019.....	119	B0143004	112	B0631003	56
51000634.....	28	B0143015	112	B0631004	56
51000636.....	28	B0143016	112	B0631005	56
51000638.....	28	B0143017	112	B0631006	56
51000817.....	28	B0143018	112	B0631007	56
51001135.....	25	B0143019	112	B0631008	56
51001137.....	25	B0143263	115	B0631009	56
51001140.....	25	B0144637	112, 113, 114	B0631010	56
51001141.....	25	B0152471	62	B0631011	56
51001144.....	31, 35	B0169319	112	B0631012	56
51001148.....	31	B0169320	112	B0631013	56
51001149.....	31	B0169321	112	B0631014	56
51001152.....	31	B0181091	113	B0631015	56
51001188.....	24	B0182864	112, 114	B0631016	56
51001324.....	24	B0182901	112, 114	B0631017	56
51001325.....	24	B0182902	112, 114	B0631018	56
51001326.....	24	B0182903	112, 114	B0631019	56
51001327.....	24	B0182905	112	B0631020	56
51001328.....	24	B0182981	113, 115	B0631021	56
51002592.....	31	B0185054	112	B0631023	56
51002593.....	31	B0185163	63	B0631025	56
51004599.....	31	B0185210	63, 67	B0631026	56
52019600.....	83	B0185227	65	B0631027	56
52123130.....	89	B0187028	67	B0631028	56
52123164.....	89	B0190034	76	B0631029	56
52123814.....	89	B0193233	76, 90	B0631030	56
52126027.....	87	B0193234	76, 90	B0631031	56
01541496	126	B0193235	76, 90	B0631032	56
01541498	126	B0196858	113	B0631033	38, 56
02190062	112	B0196912	75	B0631034	56
03190036	126	B0198030	113	B0631035	56
04820519	31	B0198093	102	B0631036	56
09908400	126	B0500952	61	B0631039	57

PART NUMBER INDEX

Part No.	Page	Part No.	Page	Part No.	Page
B0631042	57	B0631125	85	L1050247	38
B0631045	57	B0631126	85	L1050259	38
B0631046	57	B0631127	85	L1050260	38
B0631047	57	B0631128	59	L1060351	31, 35
B0631048	57	B0631130	59	L1061717	33
B0631049	57	B0631131	59	L1100998	39
B0631051	57	B0631132	84	L1101009	39
B0631057	57	B0631133	85, 90	L1101010	39
B0631060	57	B0631142	85	L1101011	38
B0631062	57	B0631149	59	L1101017	38
B0631064	57	B0631150	59	L1101018	38
B0631066	57	B0631151	59	L1108717	40
B0631070	57	B0631152	59	L1108719	41
B0631071	57	B2000049	64	L1108721	40
B0631076	57	B2000159	66, 66	L1108723	40
B0631077	57	B2000160	66	L1108725	41
B0631079	57	B2000186	63, 65	L1108727	40
B0631080	57	B2000201	63	L1108731	41
B0631081	57	B2000310	63	L1108733	40
B0631082	57	B2000515	64	L1108734	40
B0631083	57	B2190034	76	L1108735	40
B0631084	59	B2190036	76	L1108737	41
B0631085	59	B2205021	74	L1108739	41
B0631087	59	B2205022	74	L1108741	41
B0631088	59	B2205116	65, 76	L1108745	40
B0631089	59	B2205411	63, 64, 65	L1108747	40
B0631090	59	B2500080	63	L1108749	40
B0631091	59	B2500081	63	L1108751	41
B0631092	59	B2500099	78	L1108777	41
B0631093	59	B2500100	79	L1108778	40
B0631094	59	B2500103	76	L1108779	40
B0631095	59	B2500127	59	L1108780	41
B0631096	59	B2500129	59	L1108781	41
B0631097	59	B3001647	90	L1108782	41
B0631098	59	B3140617	90	L1108783	41
B0631099	59	B3140618	90	L1108784	40
B0631100	59	B3140621	90	L1108830	41
B0631101	59	B7001014	112	L1108831	41
B0631102	59	BUV05099	79	L1108832	41
B0631104	84	BUV10987	79	L1108835	41
B0631107	84	C0550500	55	L1108836	40
B0631110	84	C0550505	55	L1108837	40, 41
B0631113	84	C6951019	73	L1108838	41
B0631115	84	C6957528	55	L1108839	41
B0631116	84	C6957529	55	L1108840	40
B0631118	84	C6957775	55	L1108841	41
B0631119	84	C6957776	55	L1108842	41
B0631120	85	CP364460	83	L1108843	41
B0631122	85	HH33450003	67	L1108844	41
B0631123	85	L1050071	33	L1108845	41
B0631124	85	L1050246	39	L1108846	41

PART NUMBER INDEX

Part No.	Page	Part No.	Page	Part No.	Page
L1108847	41	L1191081	37	L1240055	38
L1108848	40	L1191082	37	L1240056	26
L1108849	40	L1200219	34	L1240057	26
L1108850	41	L1200253	34	L1240098	34
L1108851	40	L1200311	16	L1241446	21, 33
L1108852	40	L1200312	16	L1250044	21
L1108853	40	L1200313	18	L1250046	18
L1108854	41	L1200314	18	L1250048	18
L1108855	41	L1200315	18	L1250050	16
L1108856	41	L1200316	18	L1250051	16
L1108858	41	L1200321	18	L1250052	16
L1108859	41	L1200323	18	L1250053	16
L1108860	41	L1200324	18	L1250054	16
L1108861	41	L1200325	18	L1250071	21
L1108862	40	L1200333	18	L1250220	37
L1108863	40, 41	L1200334	18	L1250240	18
L1108864	41	L1200335	18	L1250241	18
L1108865	41	L1200336	18	L1250242	18
L1108866	40	L1200337	18	L1250302	16
L1108867	41	L1200338	18	L1250311	34
L1108868	41	L1200343	18	L1250404	33
L1108869	41	L1200344	18	L1250405	33
L1108870	41	L1200345	18	L1250425	33
L1108871	41	L1200346	18	L1250462	33
L1108872	41	L1200351	21	L1250463	33
L1108873	41	L1200406	34	L1250475	33
L1108874	40	L1200443	34	L1250600	23
L1108875	40	L1200551	37	L1251445	21
L1108876	41	L1200552	37	L1251632	21
L1108877	40	L1200553	37	L1251816	16
L1108878	40	L1200555	37	L1251840	34
L1108879	40	L1200556	37	L1270301	25
L1108880	41	L1200557	37	L1270401	39
L1108922	40	L1200558	37	L1270402	25
L1108923	40	L1200559	37	L1270404	25
L1108924	40	L1200560	37	L1270408	25
L1108925	40	L1200574	37	L1270409	25
L1108926	40	L1200587	37	L1270409	38
L1108932	41	L1200588	37	L1270410	25
L1160550	35	L1200589	37	L1270421	25, 35, 39
L1160560	55	L1201654	21	L1270512	25
L1160569	35	L1201655	21	L1270664	25
L1160579	35	L1201865	21	L1270666	25
L1180479	33	L1201944	18	L1270765	25
L1180480	34	L1201980	18	L1270766	26
L1180490	33	L1202023	18	L1270941	26
L1181303	26	L1202024	18	L1270942	26
L1181314	21	L1202049	18	L1270944	26
L1181316	21	L1202050	18	L1270947	26
L1185153	20	L1202057	33, 35	L1270948	26
L1191079	36	L1205436	18	L1270949	26

PART NUMBER INDEX

Part No.	Page	Part No.	Page	Part No.	Page
L1270951	26	L1272294	27	L1272360	29
L1270952	26	L1272298	27	L1272361	23
L1270954	26	L1272299	29, 29	L1272362	29
L1270957	26	L1272300	29	L1272364	29
L1270958	26	L1272301	29	L1272365	29
L1270959	26	L1272302	29	L1272366	29
L1270961	26	L1272303	29	L1272367	29
L1270962	26	L1272307	29	L1272368	29
L1270964	26	L1272308	29	L1272369	29
L1270967	26	L1272309	39	L1272370	29
L1270968	26	L1272313	19	L1272372	17
L1270986	25, 35	L1272314	19	L1272373	19
L1271021	21	L1272315	19	L1272374	19
L1271102	26	L1272316	19	L1272375	22
L1271191	25	L1272317	19	L1272376	23
L1271192	25, 35	L1272318	19	L1272377	23
L1271193	25	L1272319	19	L1272380	18
L1271194	25	L1272320	19	L1272381	17
L1271195	25	L1272321	19	L1272382	23
L1271202	26, 35, 133	L1272323	19	L1272383	23
L1271250	25	L1272324	19	L1272384	17
L1271602	26	L1272325	19	L1272386	17
L1272002	26	L1272330	17	L1272387	17
L1272126	17	L1272331	19	L1272388	17
L1272127	17	L1272332	19	L1272389	17
L1272130	19	L1272333	19	L1272390	17
L1272131	19	L1272334	19	L1272391	17
L1272133	19	L1272335	19	L1272392	17
L1272240	23	L1272336	19	L1272393	17
L1272242	23	L1272337	17	L1272394	17
L1272243	23	L1272338	19	L1272395	17
L1272247	23	L1272339	19	L1272396	17
L1272248	23	L1272340	19	L1272397	17
L1272249	32	L1272341	19	L1272398	17
L1272265	29, 35	L1272342	19	L1272399	17
L1272266	29, 35	L1272344	22	L1272400	17
L1272267	29, 35	L1272345	22	L1272401	17
L1272268	29, 35	L1272346	22	L1272402	17
L1272274	19	L1272347	22	L1272403	22
L1272275	19	L1272348	22	L1272405	22
L1272276	19	L1272349	22	L1272406	22
L1272277	19	L1272350	22	L1272407	16
L1272282	27, 32	L1272351	22	L1272409	22
L1272283	27	L1272352	22	L1272410	22
L1272284	27	L1272353	23	L1272412	17
L1272288	27	L1272354	27	L1272414	17
L1272289	27	L1272355	27	L1272422	19
L1272290	27	L1272356	27	L1272423	17
L1272291	27	L1272357	27	L1272425	19
L1272292	27	L1272358	27	L1272426	19
L1272293	27	L1272359	27	L1272427	19

PART NUMBER INDEX

Part No.	Page	Part No.	Page	Part No.	Page
L1272428	19	L1280065	18	L1365334	33
L1272433	18	L1280066	18	L1370130	28
L1272440	27	L1280069	16	L1390029	28
L1272443	17	L1280249	33	L1390041	21
L1272450	23	L1280250	33	L1390046	28
L1272451	23	L1280251	33	L1390047	28
L1272452	23	L1280301	16	L1390048	28
L1272453	23	L1280302	16	L1390049	28
L1272454	23	L1280303	16	L1390052	21
L1272455	23	L1280303	33	L1390053	21
L1272456	23	L1280304	16	L1390055	21
L1272457	23	L1280305	16	L1390110	33
L1272458	22	L1280306	21	L1390136	28
L1272459	22	L1280308	16	L1390137	28
L1272461	22	L1280312	16	L1390138	28
L1272470	29	L1280313	20	L1390147	28
L1272471	29	L1280321	16	L1390148	28
L1272472	28	L1280322	16	L1390149	28
L1272473	28	L1280323	21	L1390159	33
L1272474	28	L1280410	20	L1390187	28
L1272475	28	L1280417	20	L1390188	20, 28
L1272480	29	L1281920	20	L1390189	20, 28
L1272481	29	L1281921	20	L1390190	33
L1272482	29	L1281922	20	L1390198	21
L1272483	17	L1281923	20	L1390205	20
L1272484	19	L1281924	20	L1390221	21
L1272485	19	L1281925	20	L1390222	21
L1272486	19	L1281926	20	L1390223	21
L1272487	19	L1281927	20	L1390224	21
L1272490	36	L1281928	20	L1390225	20
L1272491	31	L1281929	20	L1390235	28
L1272492	31	L1281930	20	L1390271	33
L1272493	31	L1281931	20	L1391230	28
L1272494	31	L1281932	20	L1391232	28
L1272495	36	L1281933	20	L1391233	28
L1272496	36	L1281934	20	L1391234	28
L1272498	36	L1360266	18	L1391235	28
L1272501	33	L1360267	18	L160001F	36
L1272502	33	L1360268	18	L160001G	36
L1272503	16	L1360269	18	L160001H	36
L1272504	16	L1360270	18	L1600107	16
L1272505	16	L1360271	18	L1600109	16
L1272506	16	L1360272	18	L1600111	21
L1272511	16	L1360273	18	L1600113	16, 39
L1272512	16	L1360275	18	L1600114	17
L1272513	16	L1362335	35	L1600115	17
L1272514	16	L1362336	35	L1600116	17
L1275102	21	L1362458	35	L1600117	39
L1275105	21	L1362460	35	L1600119	22
L1275106	21	L1365311	35	L1600130	27
L1280064	18	L1365312	35	L1600133	33

PART NUMBER INDEX

Part No.	Page	Part No.	Page	Part No.	Page
L1600217	16	L1860361	32	L6022024	73
L1600225	16	L1860409	32	L6022025	73
L1600232	33	L1860670	32	L6022728	55
L1600233	33	L1861634	32	L6025049	79
L1600238	33	L2151202	91	L6310010	68
L1600241	33	L2151203	90, 91	L6310011	67, 68
L1600242	33	L2151204	90	L6310012	68
L1600243	33, 34	L2250042	91	L6310013	68
L1600244	33, 34	L2250101	89	L6310014	66
L1600246	33	L2250134	87	L6310204	79
L1600350	36	L2250135	90	L6310211	70, 71
L1600371	16	L2250135L	90	L6310215	71
L1601742	16	L2250136	87	L6310216	71
L1601743	16	L2250138	91	L6310220	73
L1601856	16	L2250139	85	L6310240	77
L1608001	35, 38	L2250140	87	L6310242	77
L1608002	35, 38	L2250141	87	L6310243	77
L1608003	39	L2250144	88	L6310244	77
L1608004	38	L2250145	87	L6310246	77
L1608005	38	L2250162	87	L6310247	77
L1608006	38	L2251157	83	L6310248	71
L1608007	38	L2251223	90, 91	L6310250	30
L1608008	39	L2251293	83	L6310251	30
L1608009	39	L2251365	83	L6310254	77
L1608010	39	L2258003	90	L6310255	77
L1608012	39	L6000500	63, 65, 66	L6311024	30
L1608013	38	L6020116	71	L6311025	30
L1608015	39	L6020117	71	L6311026	30
L1608022	35	L6020118	71	L6311027	30
L1608117	39	L6020202	69, 74	L6311028	30
L1608118	39	L6020203	72	L6311029	30
L1608121	39	L6020208	69, 74	L6311030	30
L1608122	38	L6020211	70	L6311031	30
L1608124	39	L6020276	55	L6311032	30
L1608126	38	L6020277	55	L6311033	30
L1608128	39	L6020290	75	L6311034	30
L1608129	38, 39	L6020291	76	L6311035	30
L1610015	36	L6020314	73	L6311036	30
L1610016	36	L6020316	73	L6311037	30
L1610021	36	L6020318	79	L6311038	30
L1610022	36	L6020319	72, 73	L6311039	30
L1610023	36	L6020319	79	L6311040	30
L1610028	36	L6020328	74	L6311041	30
L1860268	32	L6020358	69, 74	L6311042	30
L1860269	32	L6020360	64, 65	L6311043	30
L1860275	32	L6020364	70, 73	L6311044	30
L1860298	32	L6020365	70, 72	L6311045	30
L1860317	32	L6020371	73	L6311046	30
L1860318	32	L6020372	72	L6311052	30
L1860319	32	L6022022	72, 73	L6311053	30
L1860334	32	L6022023	73	L6311054	30

Part No.	Page	Part No.	Page	Part No.	Page
L6311055	30	L8200066	128	L9003439	119
L7110260	60	L8200078	131	L9003631	38, 39
L7110261	60	L8200079	131	L9003632	38, 39
L7110262	60	L8200080	128	L9004128	33
L7110264	60	L8200081	128	L9004196	20
L7110266	60	L8200082	128	L9004198	33
L7110267	60	L8200083	128	L9004199	33
L7110268	60	L8200084	128	L9004200	33
L7110269	60	L8200085	128	L9004319	16
L7110271	60	L8200086	128	L9004573	20
L7110272	60	L8200087	128	L9004574	20
L7110273	60	L8200100	128	L9004575	20
L7110274	60	L8200101	128	L9004578	20
L7110275	60	L8200102	128	L9004741	55
L7110289	58	L8200103	128	L9004783	126
L7110290	58	L8200104	128	L9004892	20
L7110291	58	L8200105	128	LX108911	39
L7110292	58	L8200106	128	LX108939	39
L7110293	58	L8200107	128	LX108940	38, 39
L8040020	125	L8200108	128	LX108946	39
L8040021	125	L8200109	128	N0171159	34
L8040022	125	L8200110	128	N0207173	89
L8040200	125	L8200111	128	N0207173	90
L8040201	125	L8200112	128	N0777063	36
L8040202	125	L8200113	128	N0777064	36
L8041600	126	L8200114	128	N0777099	36
L8041601	126	L8200115	128	N0777167	36
L8041800	126	L8200116	132	N0777599	36
L8041801	126	L8200117	132	N0830015	76, 90
L8041802	126	L8200244	129	N1010504	79
L8041803	126	L8200245	129	N1010520	74
L8041808	126	L8201007	133	N1010539	78, 79
L8041809	126	L8201012	133	N1010540	78, 79
L8041816	126	L8201801	129, 132, 133	N1010545	78
L8041838	126	L8201802	133	N1010565	66
L8041840	125	L8201804	129, 130, 131, 132	N1010566	66
L8200051	128	L8201805	129	N1010567	63
L8200052	128	L8201810	132	N1010568	63
L8200053	128	L8201813	129, 130, 131, 132	N1010569	63
L8200054	128	L8201818	129, 132, 133	N1015158	64, 65, 68
L8200055	128	L8201819	133	N1016002	55
L8200056	128	L8201821	129, 133	N1016070	75
L8200057	128	L8201825	129, 133	N1016071	75
L8200058	128	L8201881	129, 130, 131, 132, 133	N1016072	75
L8200059	128	L8201950	131, 132	N1016073	75
L8200060	128	L8201954	133	N1016074	75
L8200061	128	L8201957	130, 131, 132	N1870151	32
L8200062	128	L90004787	113	N1870184	32
L8200063	128	L90004788	113	N1870185	32
L8200064	128	L9001020	16	N1870188	32
L8200065	128	L9002298	33	N1873300	40

PART NUMBER INDEX

Part No.	Page	Part No.	Page	Part No.	Page
N1873302	40	N2410188	97	N2411291	96, 97
N1873304	41	N2410191	97	N2411300	95, 97
N1873305	40	N2410212	97	N2411333	98, 102
N1873308	41	N2410234	96	N2411335	98
N1873309	40	N2410237	100	N2411341	96, 100
N1873310	41	N2410244	102	N2411342	96, 100
N1873311	41	N2410265	98	N2411359	97, 101
N1873312	41	N2410267	94, 98	N2411362	102
N1873313	40	N2410277	97	N2411363	102
N1873314	41	N2410278	96, 97	N2411364	102
N1873315	41	N2410315	100	N2411401	95, 96, 98
N1873316	40	N2410320	102	N2411514	95, 96, 97
N1873318	41	N2410322	96	N2411527	97
N1873319	40	N2410323	95, 96	N2411701	97
N1873320	41	N2410324	97	N2411702	102
N1873321	40	N2410325	97	N2411703	102
N1873323	41	N2410327	99	N2411704	102
N1873325	41	N2410330	97	N2411705	102
N1873327	41	N2410331	97	N2411706	102
N1873369	40	N2410332	97	N2411707	102
N1873370	40	N2410501	97	N2411708	102
N1873371	40	N2410502	99	N2411709	102
N1873372	40	N2410503	99	N2411710	103
N1873374	40	N2410506	95	N2411711	103
N1873375	41	N2410507	95	N2411712	103
N1873376	41	N2410510	94	N2411713	103
N1915158	65	N2410510	96	N2411714	103
N2020004	90	N2410513	95	N2411715	103
N2020010	90	N2410518	97	N2411716	103
N2141401	95	N2410681	95	N2412088	101
N2410016	98	N2410682	95	N2420214	100
N2410018	98	N2410683	95	N2421070	97
N2410092	97	N2410692	95	N4100040	66, 67, 68, 88
N2410101	94, 98	N2410693	95, 98	N4100104	64
N2410108	96	N2410694	95, 98	N4100125	66
N2410133	103	N2410695	95, 98	N4101001	62
N2410145	95, 98	N2410696	95, 96, 98	N4101002	62
N2410146	94, 96	N2410697	95, 96, 98	N4101003	62
N2410147	96, 99	N2410698	95, 96, 98	N4101005	61
N2410152	96	N2411019	103	N4101006	64
N2410153	97	N2411087	101	N4101007	65
N2410154	97	N2411088	96, 101	N4101011	70
N2410155	96, 102	N2411117	100	N4101012	76
N2410157	97	N2411118	96, 100	N4101013	75
N2410164	97	N2411144	96, 103	N4101014	65
N2410165	97	N2411235	97	N4101015	67, 71
N2410166	97	N2411255	95, 96, 102	N4101016	67, 71
N2410168	96	N2411257	96, 101	N4101017	71
N2410169	99	N2411264	97	N4101018	61
N2410170	96, 99	N2411267	96, 103	N4101019	62
N2410172	99, 99	N2411273	98	N4101020	58
N2410177	98	N2411274	96, 103	N4101021	58

PART NUMBER INDEX

Part No.	Page	Part No.	Page	Part No.	Page
N4101022	58	N4104006	62	N4202032	88, 91
N4101023	58	N4104007	62	N4202034	91
N4101024	58	N4104008	70	N4202035	83
N4101025	62, 69	N4104012	75	N4202036	83
N4101026	65, 76	N4104013	65	N4202039	85
N4101027	61	N4104014	71, 91	N4202040	90
N4101028	62	N4104015	71, 91	N5100515	118
N4101030	62, 66, 69	N4104016	55	N5190180	113
N4101031	58	N4104017	55	N5190276	118
N4101032	58	N4104018	64	N5190282	120
N4101033	58	N4104019	64	N5190283	120
N4101034	58	N4104020	64	N5190285	120
N4101035	58	N4201010	86	N5190376	126
N4101036	55	N4201011	87	N5190377	126
N4101037	55	N4201012	87	N5190378	126
N4101038	58	N4201012	90, 91	N5190393	126
N4101039	58	N4201013	86	N5190399	126
N4101040	58	N4201014	86	N5190416	126
N4101041	58	N4201015	86	N5190462	117
N4101042	58	N4201016	87, 90, 91	N5190609	126
N4101043	58	N4201017	91	N5190611	126
N4101044	58	N4201018	86	N5190615	126
N4101045	58	N4201019	90	N5190616	119
N4101046	58	N4201020	91	N5190619	125
N4101047	58	N4201021	91	N5190762	115
N4101048	75	N4201022	90	N5190788	112, 114, 118
N4101049	70	N4201023	89	N5190869	119
N4101052	76	N4201024	88, 91	N5191549	126
N4101053	67	N4201025	86	N5191555	118
N4101055	76	N4201026	88	N5191662	126
N4101060	67	N4201027	88, 90, 91	N5191700	126
N4101061	67	N4201028	89	N5200002	110, 111
N4101062	67	N4201029	88	N5200039	121
N4101063	67	N4201030	88	N5200040	116, 121
N4101090	67	N4201031	90	N5200042	119, 121
N4101091	68	N4201032	84, 86	N5200043	121
N4101505	75	N4201034	88	N5200045	116, 121
N4101506	75	N4201035	89	N5201022	121
N4103000	61	N4201036	89	N5201023	121
N4103001	65	N4201037	89	N5201024	121
N4103002	61	N4201038	89	N5202002	113
N4103003	62	N4201039	90	N5202007	121
N4103004	62	N4201040	90	N5202024	121
N4103006	65	N4201041	90	N5202029	121
N4103007	63	N4201042	90	N5202032	121
N4103008	55	N4201043	90	N5202058	113
N4104000	61	N4201045	87	N5202066	121
N4104001	65	N4201046	88	N5202067	121
N4104002	65	N4202015	83	N5202068	111
N4104003	61	N4202020	83	N5202070	111, 116, 121
N4104004	62	N4202030	84, 91	N5202071	121
N4104005	62	N4202031	91	N5202083	121

PART NUMBER INDEX

Part No.	Page	Part No.	Page	Part No.	Page
N5202088	121	N5321003	118	N5330613	124
N5202100	111	N5321004	118	N5331098	123
N5202101	111	N5322029	119	N5331136	124
N5202102	116	N5330068	123	N5331243	124
N5202103	121	N5330075	123	N5331244	124
N5202104	111	N5330177	123	N5331303	123
N5202105	111	N5330178	123	N5331308	124
N5202106	111	N5330210	122	N5331309	124
N5202122	121	N5330220	124	N5331310	124
N5203115	113	N5330254	122	N5335012	124
N5203117	121	N5330259	122	N5337024	124
N5203153	121	N5330267	124	N5340016	98, 110, 121
N5203203	113	N5330268	123, 124	N5340021	110, 111
N5203204	113	N5330270	122, 123	N5340027	110
N5203205	113	N5330300	124	N5340037	110
N5203208	113	N5330301	124	N5340038	110
N5203209	113	N5330302	124	N5340039	111
N5300001	33	N5330303	124	N5340040	111
N5300002	33	N5330304	124	N5340041	111
N5320014	116	N5330305	124	N5340046	111
N5320016	117	N5330306	124	N5340047	111
N5320026	116	N5330307	124	N5340111	111
N5320061	128	N5330308	124	N5340195	110
N5320062	128	N5330309	124	N5340229	115, 121, 126
N5320063	128	N5330310	124	N5340287	110
N5320064	128	N5330311	124	N5340400	110
N5320069	130	N5330313	124	N5340401	110
N5320070	130	N5330314	124	N5340509	111
N5320102	116, 118	N5330315	124	N5340800	115
N5320103	116, 118	N5330316	124	N5361078	115, 121
N5320111	119	N5330317	124	N5361180	115
N5320112	119	N5330318	124	N5365048	123, 124
N5320115	116	N5330319	124	N5365049	123
N5320116	116	N5330320	123	N5370015	128
N5320117	116	N5330322	123	N5370016	128
N5320118	116	N5330323	123	N5370060	129, 130, 131, 132
N5320119	116, 118	N5330324	123	N5370103	99, 117
N5320122	118	N5330338	124	N5370123	112
N5320128	116, 119	N5330340	124	N5370140	119
N5320129	116, 119	N5330341	124	N5370185	118
N5320130	116, 119	N5330342	124	N5370195	118
N5320131	118	N5330343	124	N5370220	110, 116, 117, 121, 122, 125
N5320133	116	N5330344	124	N5370221	110, 116, 121, 122, 125
N5320133	119	N5330401	122	N5370333	117, 121
N5320140	116, 118	N5330402	124	N5370342	116
N5320150	118	N5330403	124	N5370435	117
N5320201	116, 119	N5330404	124	N5370438	119, 121
N5320203	133	N5330405	124	N5370448	110
N5320204	129	N5330411	122, 123	N5370449	110
N5320205	131	N5330600	123	N5370459	118, 120
N5320206	130	N5330604	123, 124	N5370464	118, 120
N5320207	132	N5330612	123	N5370466	116, 118, 119

Part No.	Page	Part No.	Page	Part No.	Page
N5370472	118	N9302640	26	PELA9011	79
N5370478	116, 120	N9302642	26	PELA9012	79
N5370487	120	N9302643	26	PELA9013	79
N5370488	120	N9302741	60	PELA9018	79
N5370490	120	N9302742	60	PELA9019	79
N5370492	118, 120	N9302743	60	PELA9020	79
N5370550	117, 118, 120	N9308279	37	PELA9021	79
N5370551	118	N9308280	37	PELA9038	73
N5370553	116, 117	N9308281	37	PELA9039	73
N5370554	117, 120, 121	N9308282	37	PELA9040	69
N5370555	120	N9308283	37	PELA9057	79
N5370562	118	N9308284	37	PELA9058	79
N5370745	128	N9308285	37	PER23313	49
N5370746	128	N9308290	37	PER23562	48
N5373009	111	N9308291	37	PER24229	49
N5374092	124	N9308292	37	PER25435	49
N5374098	111	N9308293	37	PER27723	48
N5374099	111	N9308294	37	PER27723	49
N5376097	115	N9308295	37	PER28104	48
N5376521	118	N9308296	37	PER29233	48
N5376522	118, 116, 118	N9308298	37	PER29542	49
N5376741	116	N9308350	36	PER29693	48
N5376742	116	N9308351	36	PER30456	48
N5376775	117	N9308352	36	PER31512	49
N5376776	117	N9308354	36	PER31869	48
N5376800	121	N9308375	36	PER32458	48
N5376802	121	N9308376	36	PER32761	48
N5376819	121	N9308377	36	PER35120	49
N5380057	119, 121	N9308379	37	PER35121	49
N5380058	119, 121	N9308380	36	PER35201	48
N5380071	119, 121	N9308388	37	PER36361	49
N5390137	125	N9308389	37	PER708820	49
N5391051	126	N9308396	37	PER720504	48
N5391054	126	N9308397	37	PER720506	48
N5391181	126	N9308398	37	PER720545	48, 49
N9300086	35	N9308399	37	PER721032	49
N9300850	36	N9308730	37	PER721180	48
N9301176	117	N9308900	36	PER722002	48
N9301178	117	N9308901	36	PER723230	49
N9301355	130	N9308904	36	PER723301	48
N9302600	32	PELA1003	74	PER723321	49
N9302603	32	PELA1005	75	PER729951	48
N9302605	32	PELA1006	75	PER729952	48
N9302609	32	PELA1007	75	PER729960	49
N9302610	32	PELA1008	75	PER729970	48
N9302611	32	PELA1010	75	PER729978	49
N9302612	32	PELA1011	75	PER729979	48
N9302614	32	PELA1012	75	PER729981	48, 49
N9302615	32	PELA1013	75	PER729984	48
N9302619	32	PELA1014	75	PER729996	48
N9302620	26	PELA1015	75		
N9302622	32	PELA9010	79		

JCANO INGENIERIA DE MÉXICO:
Priv. Brunel Mz. 1 Lt. 5 Cs 4-B Fracc. Quinta Versalles
C.P. 55767 Tecámac, Edo. De México
Correo: mcano@jcanoingenieria.com
Página Web: <https://jcanoingenieria.com>
Tel: 55 3996 2586
WhatsApp: 55 7129 9832
Facebook: <https://www.facebook.com/JCanolIngenieria>

PerkinElmer, Inc.
940 Winter Street
Waltham, MA 02451 USA
P: (800) 762-4000 or
(+1) 203-925-4602
www.perkinelmer.com



For a complete listing of our global offices, visit www.perkinelmer.com/ContactUs

Copyright ©2020, PerkinElmer, Inc. All rights reserved. PerkinElmer is a trademark of PerkinElmer, Inc. All other trademarks are the property of their respective owners.